

# Beem On

500Wc

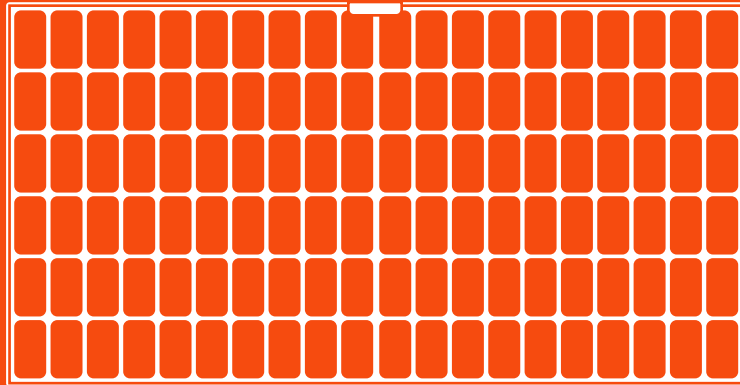

# Hey!

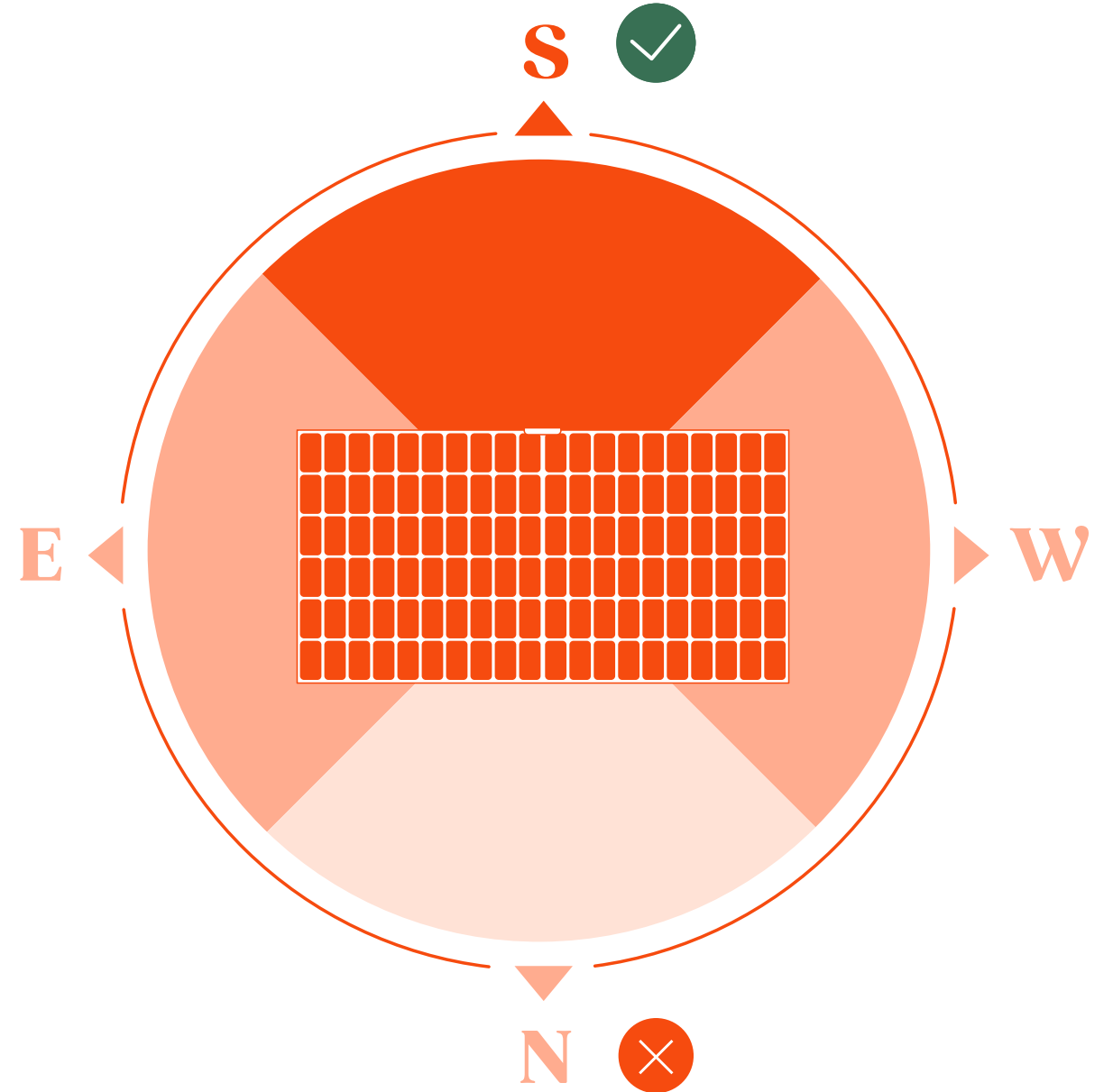
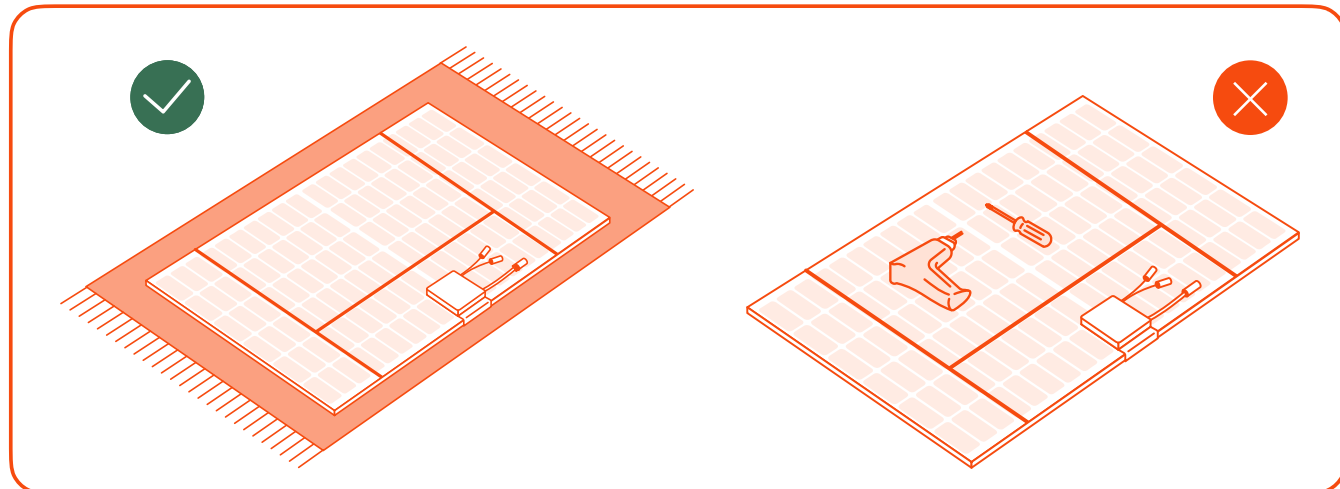
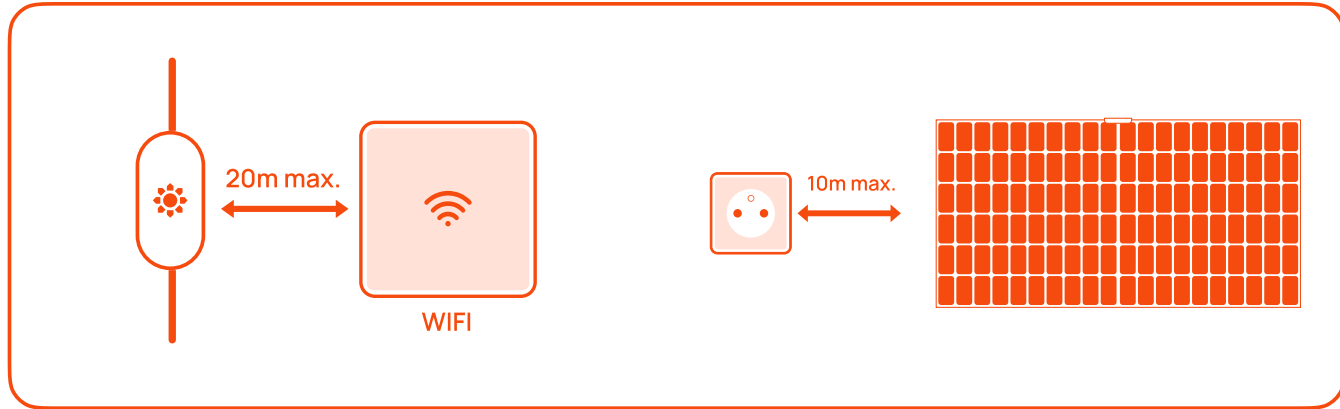
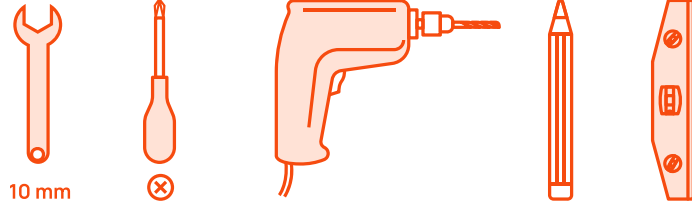

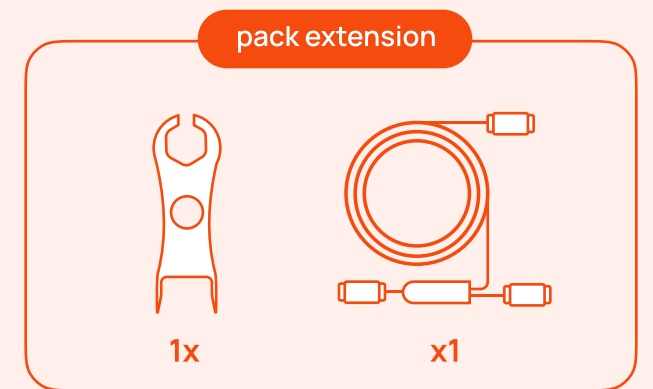
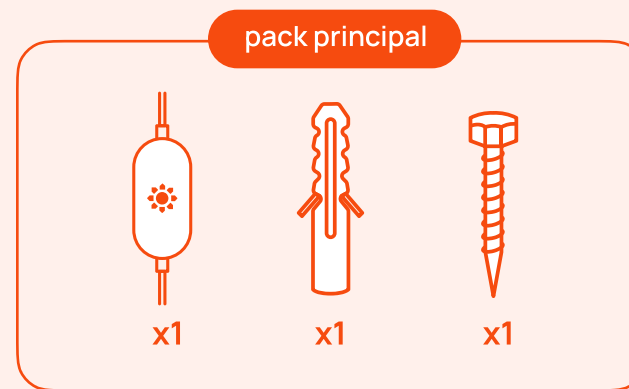
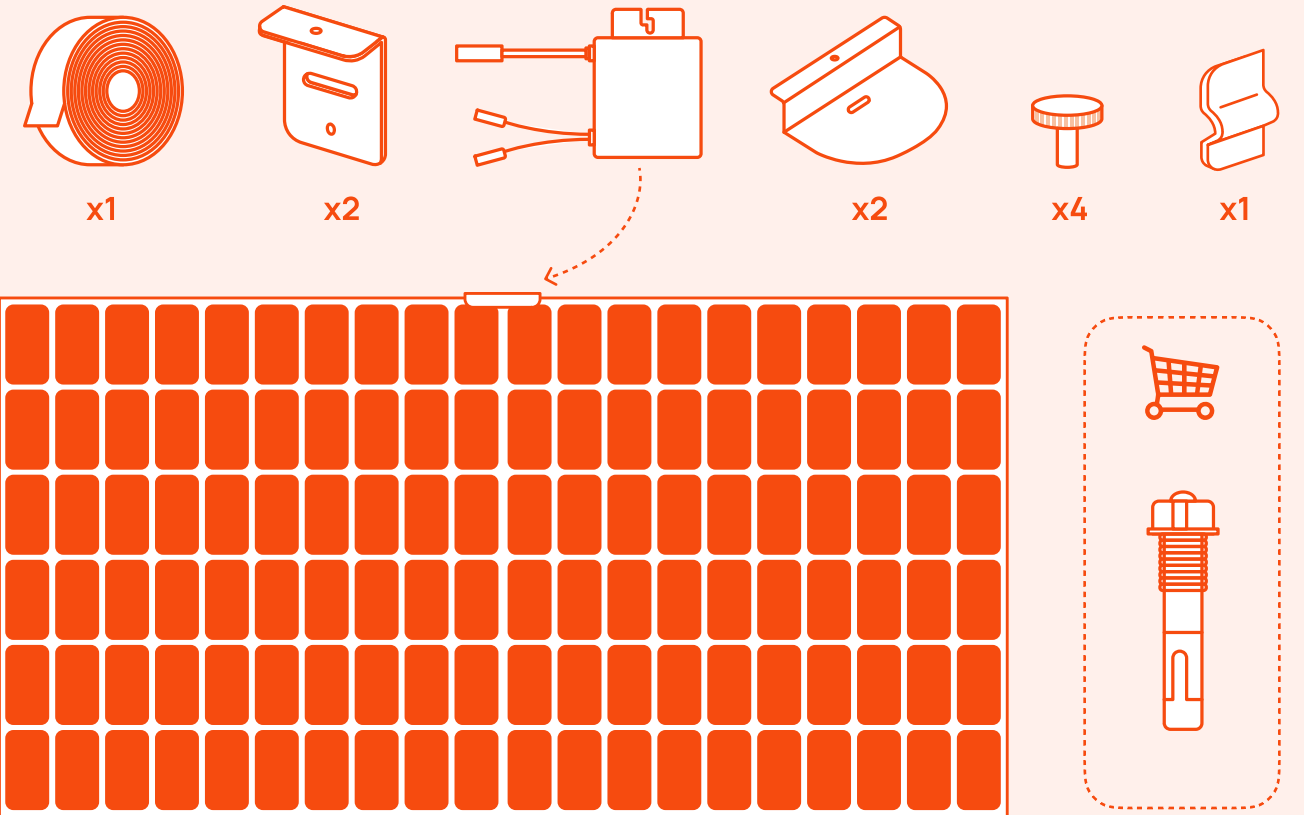
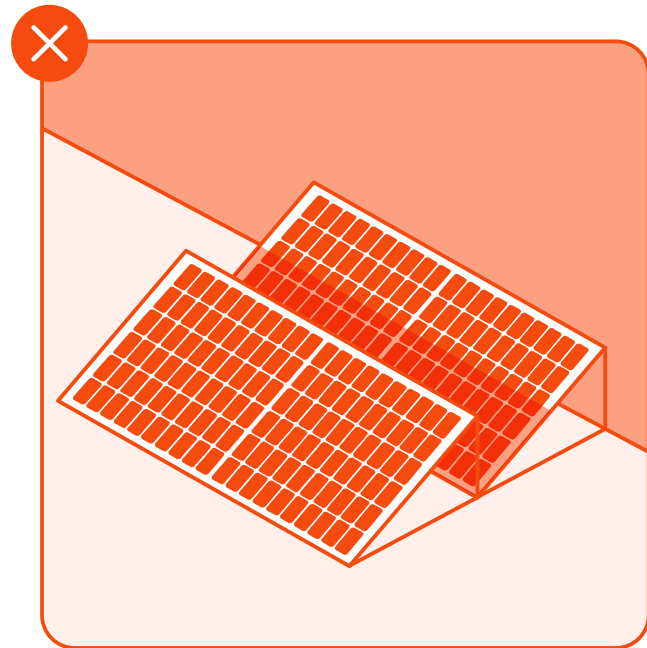
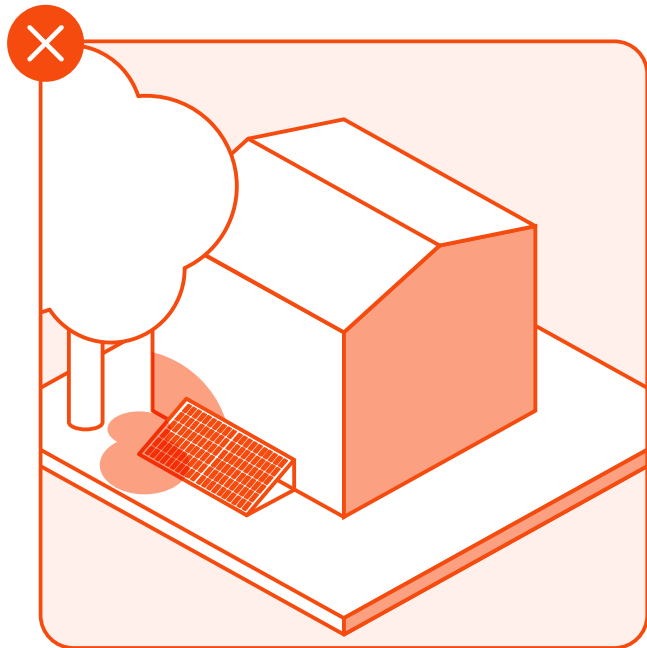
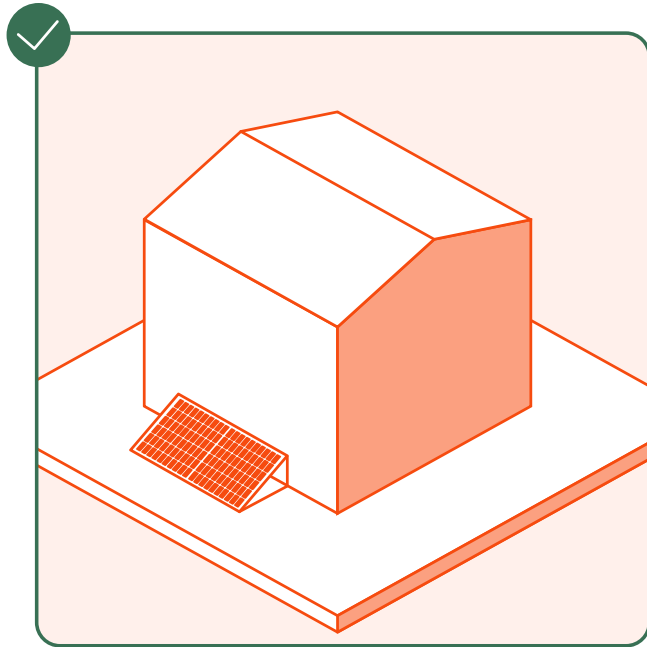
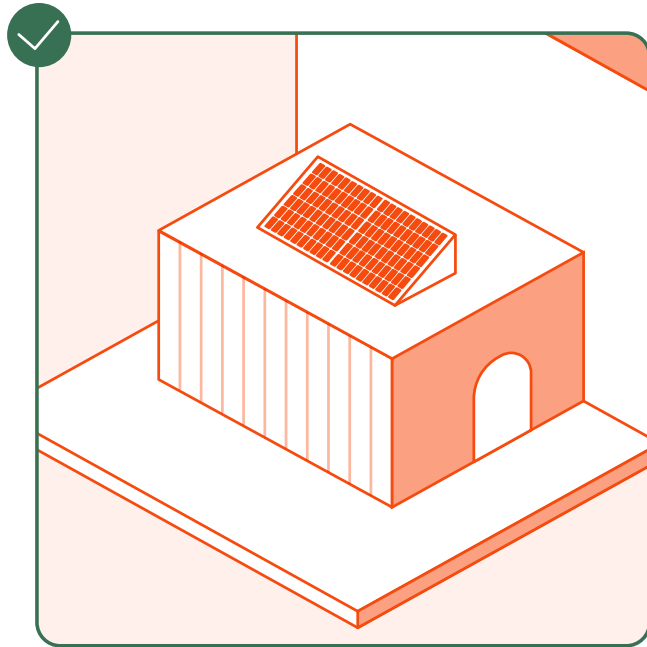

**a** P. 7

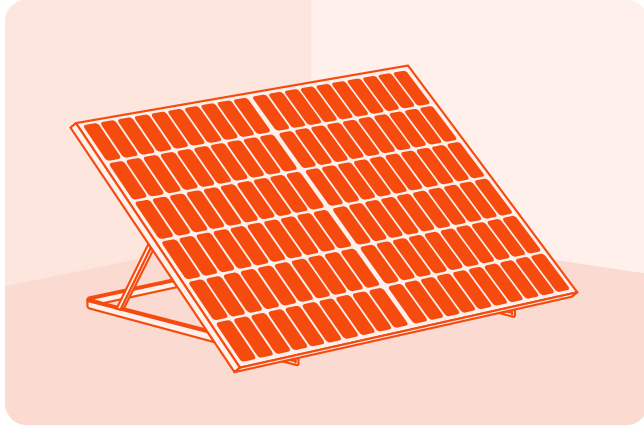

**b** P. 11

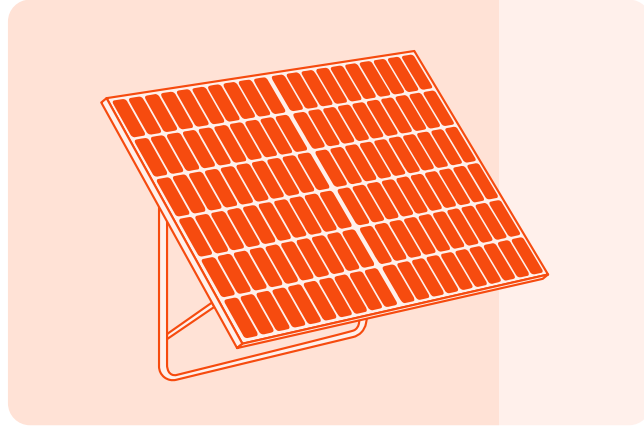

**c** P. 17

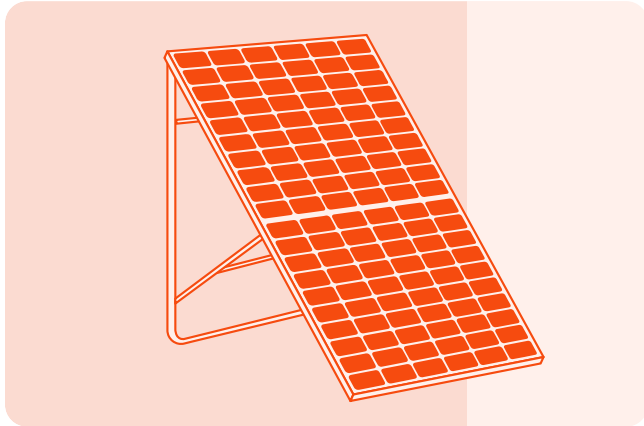

**d** P. 24

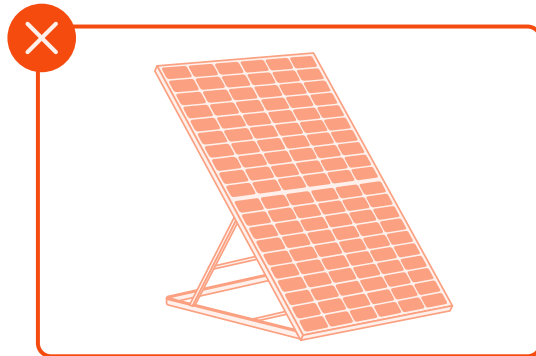
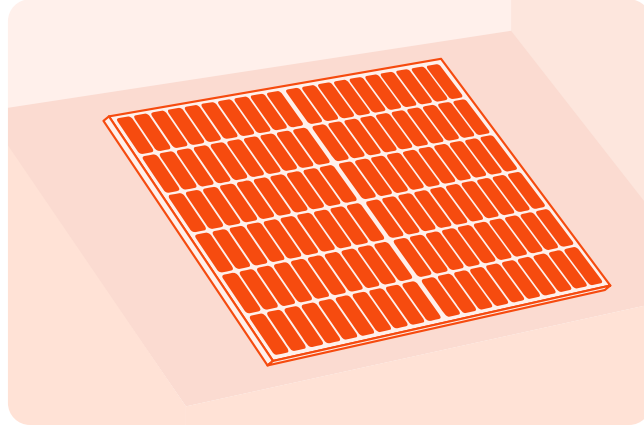

**a**

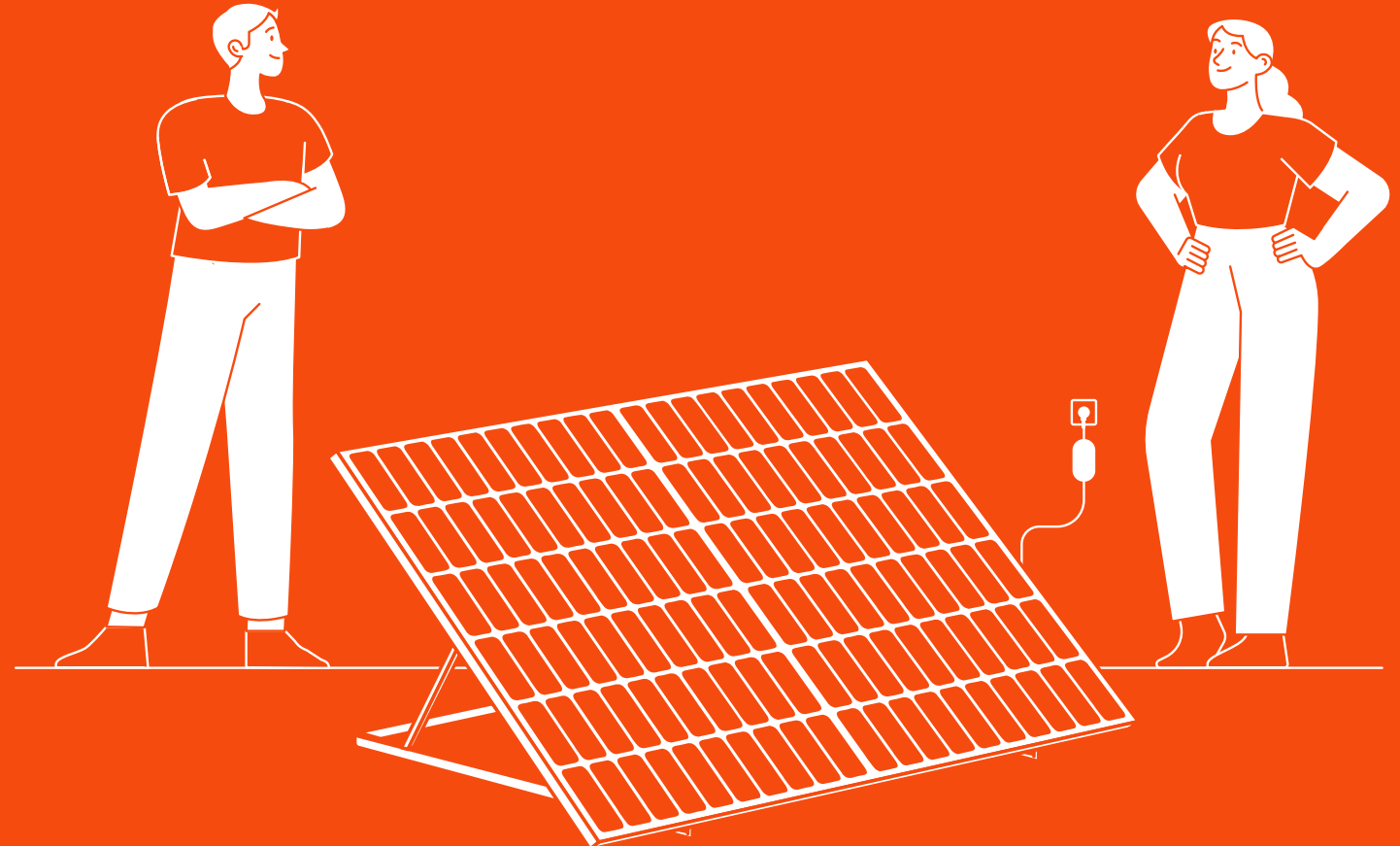

Start →

a

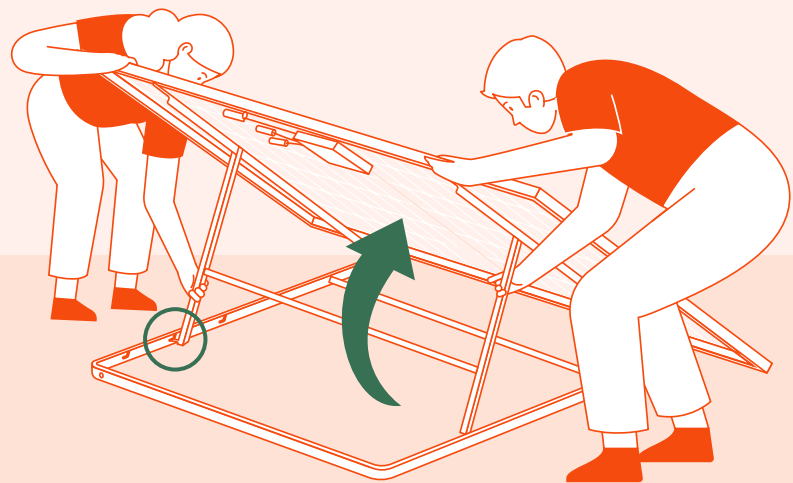

Summer  
Été

1

Mid-Season  
Mi-Saison

2

Winter  
Hiver

3

Flat  
À plat

4

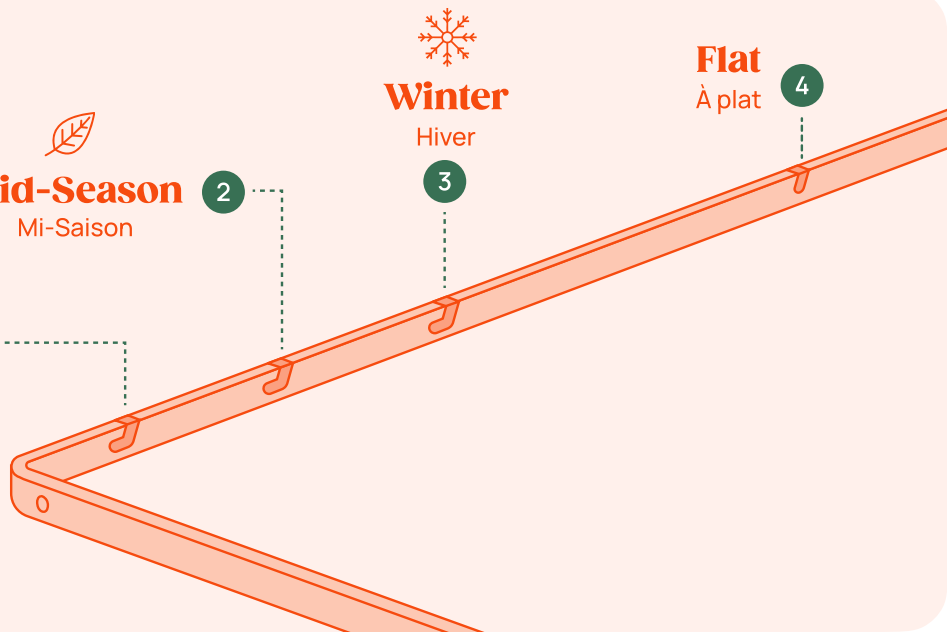

a

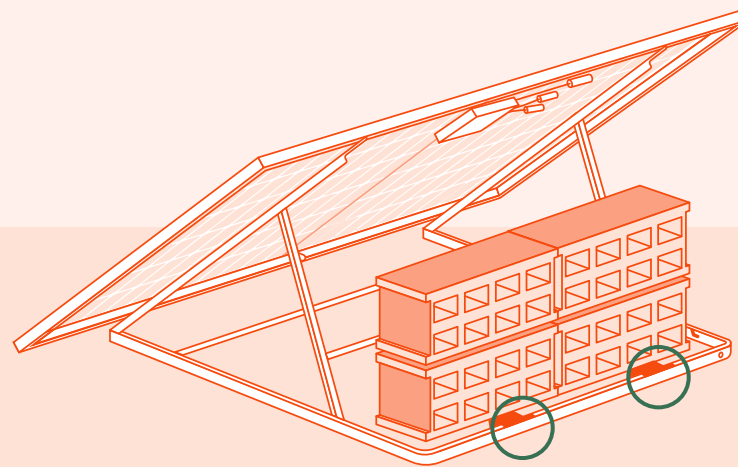

≥40 Kg

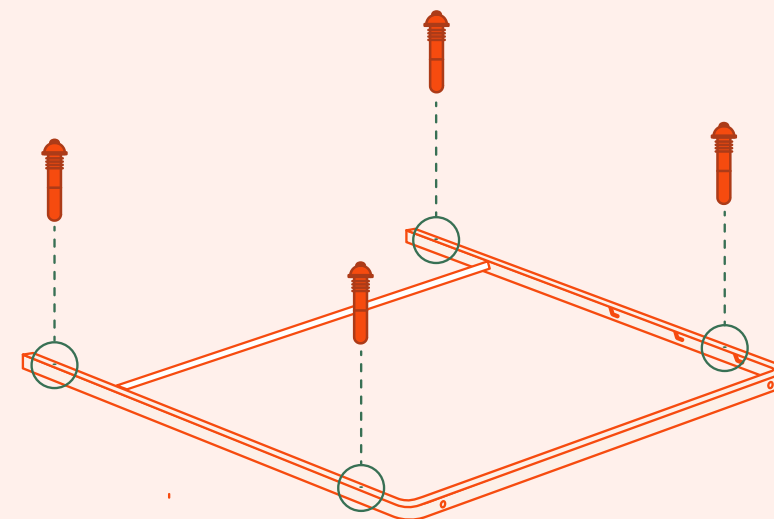
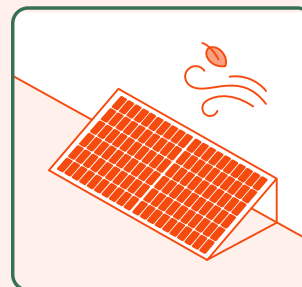
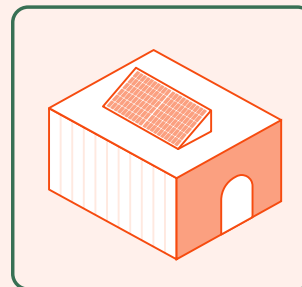
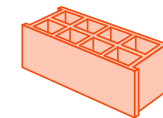

a

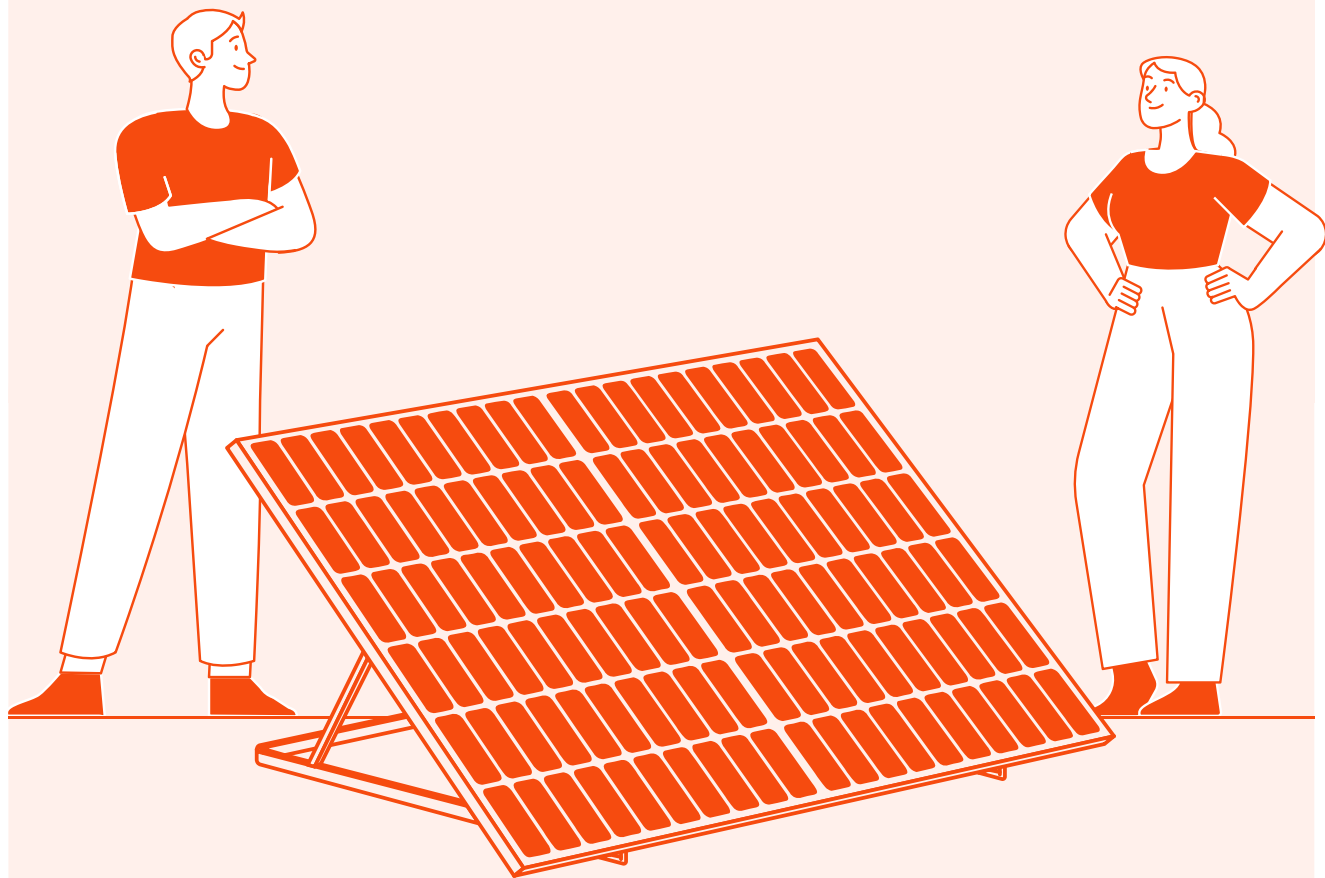

→ Page 30



b

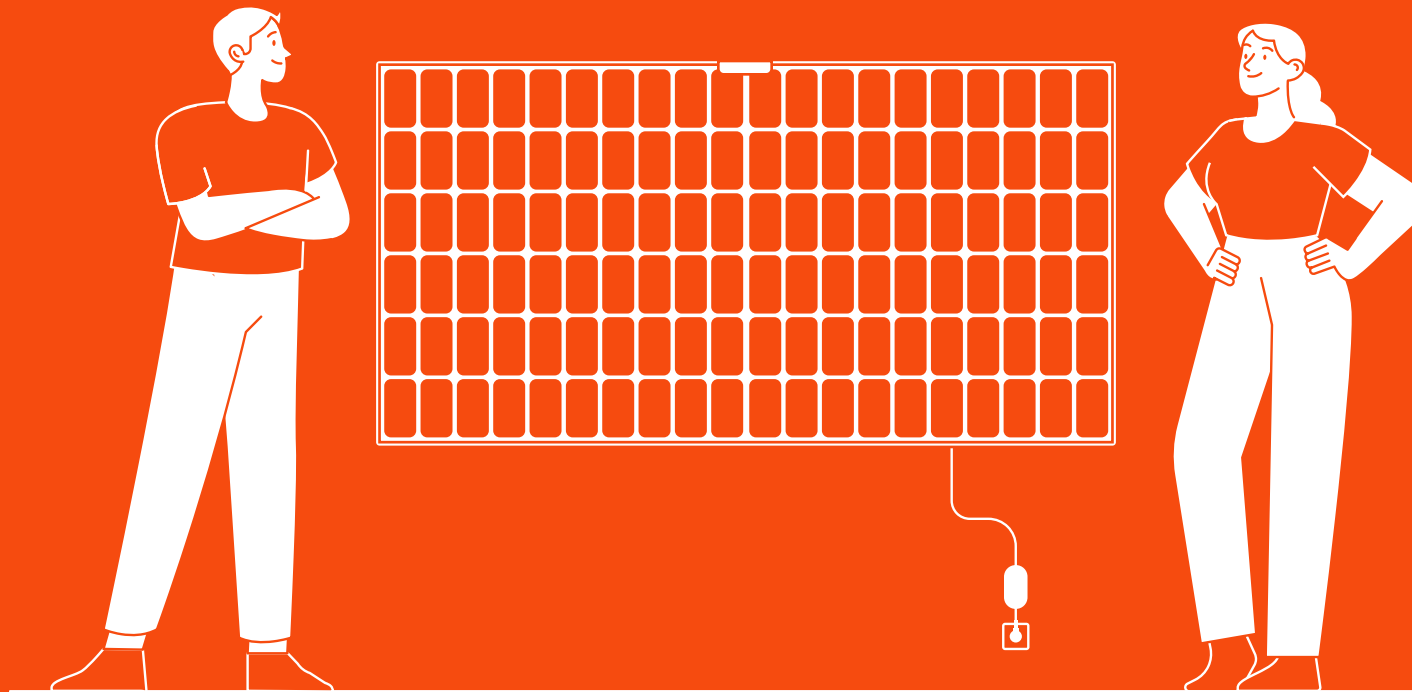

Start →

# b

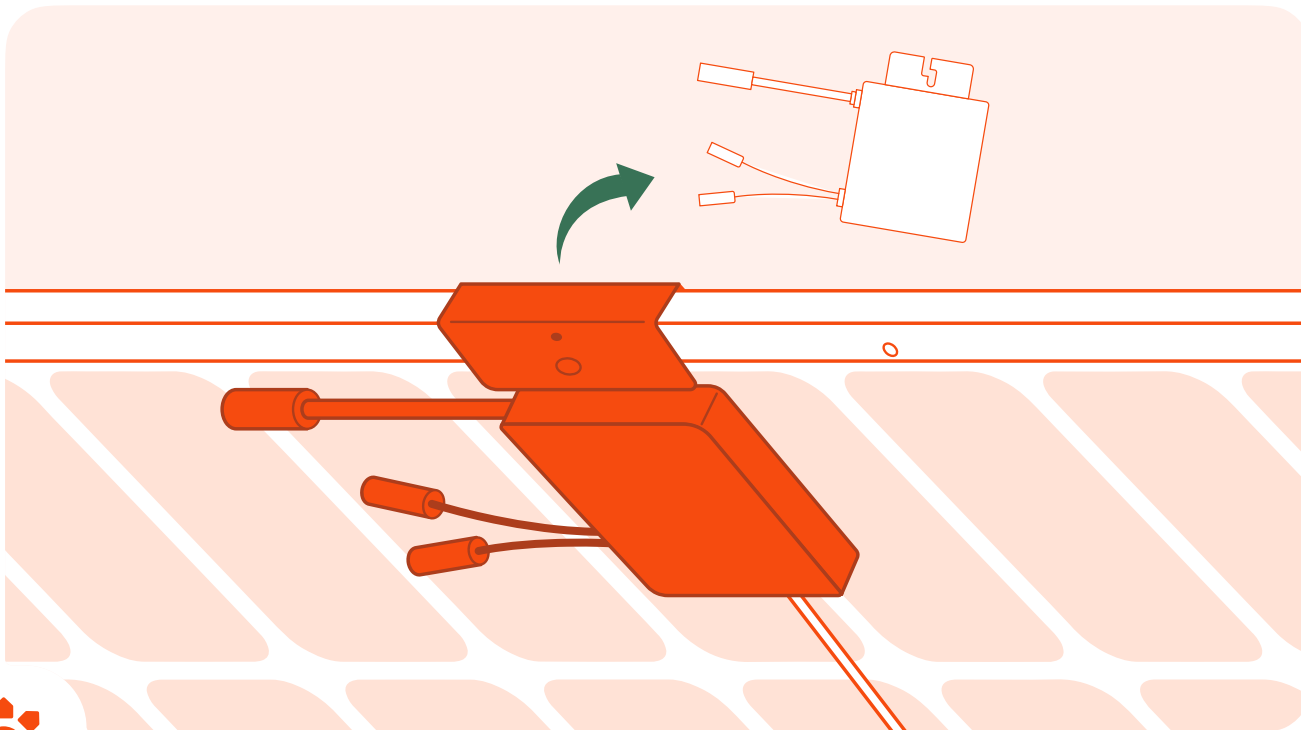
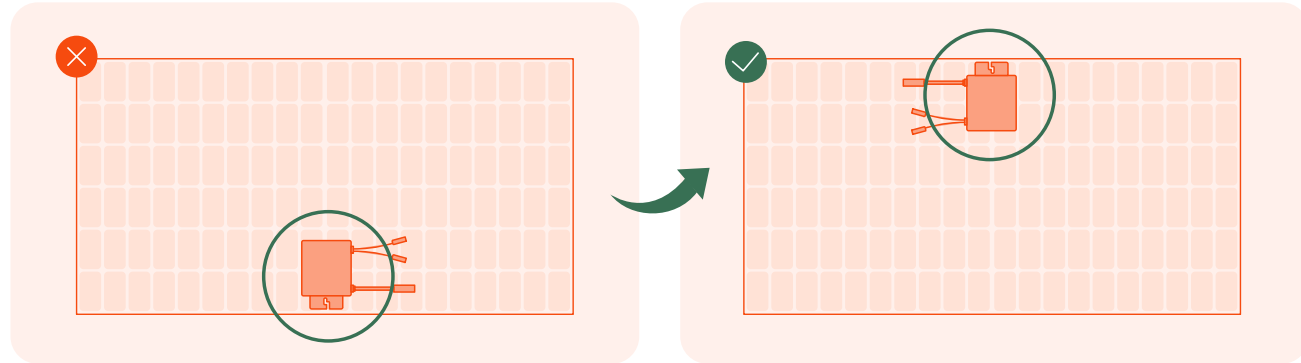

# b

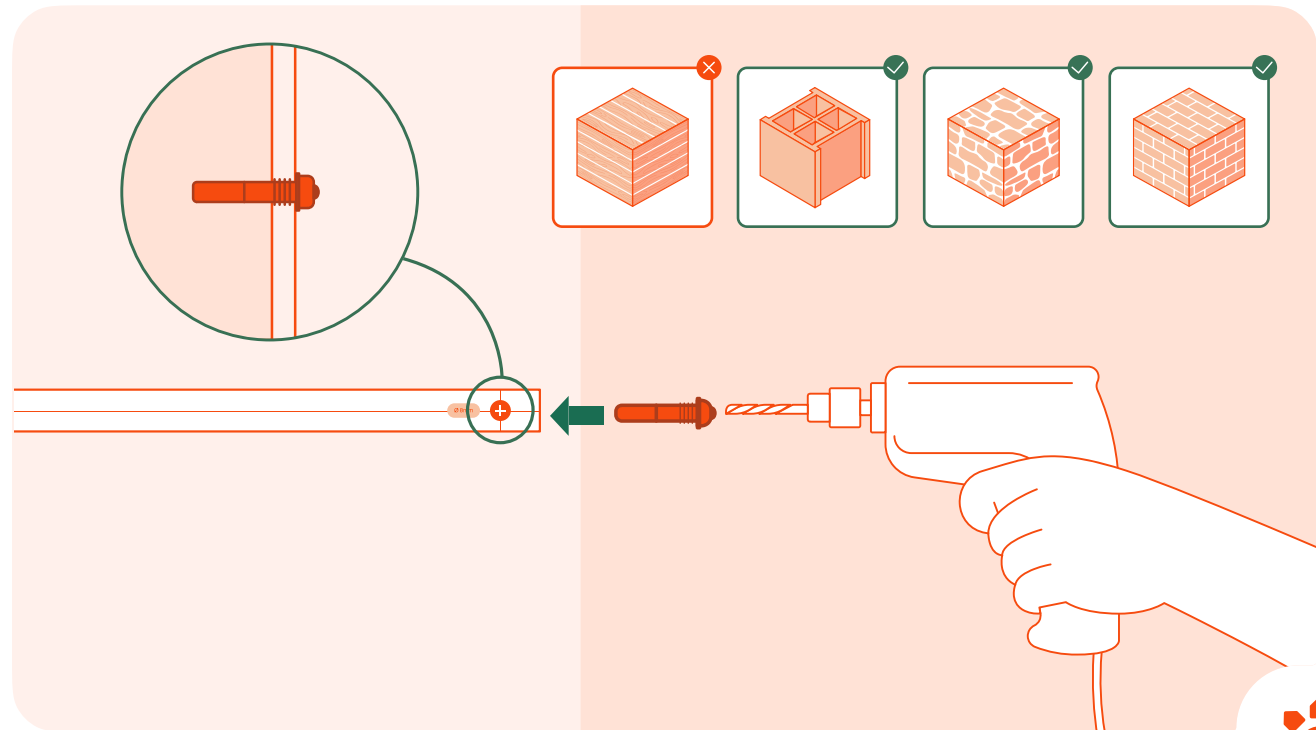
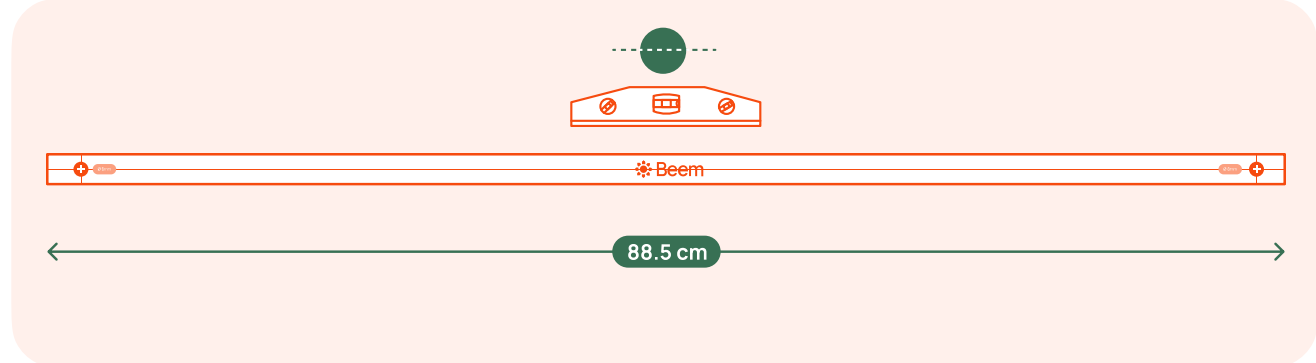
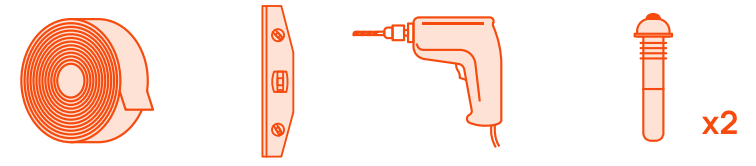

# b

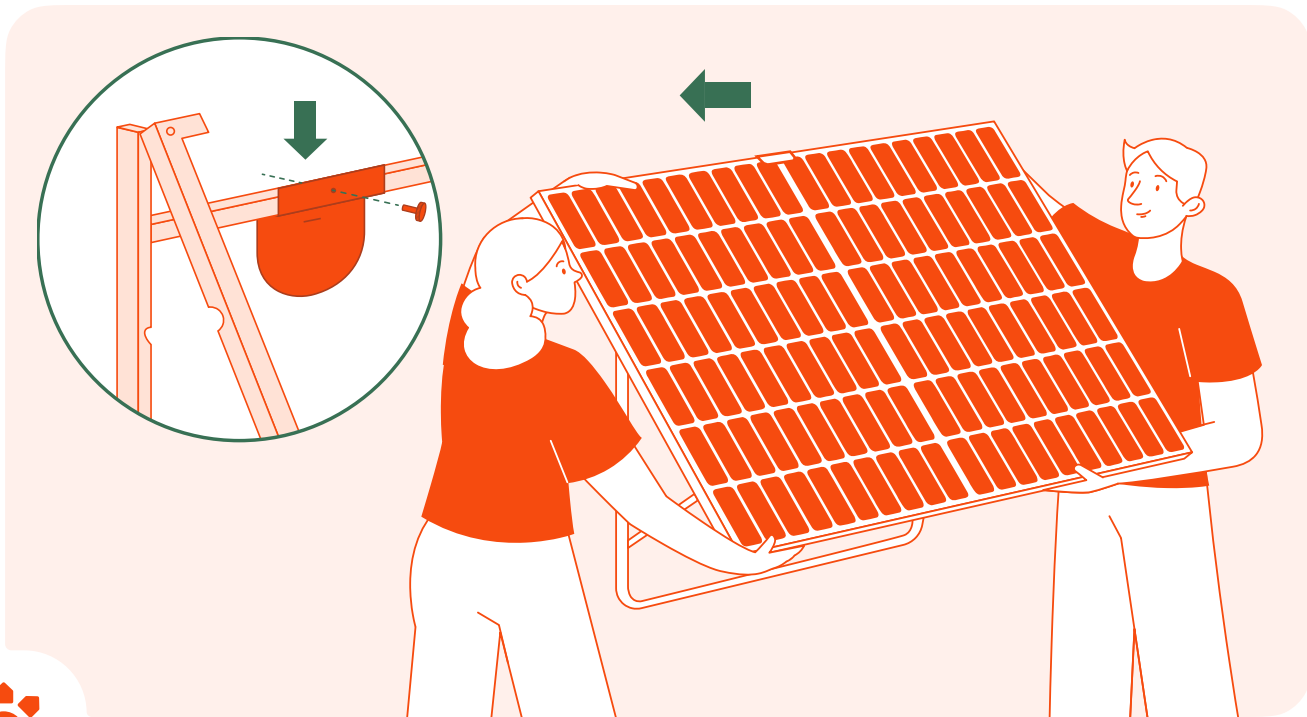
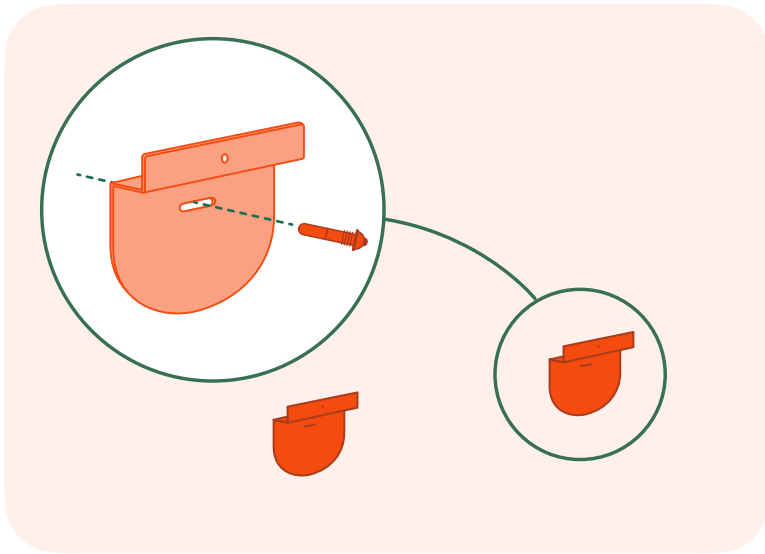
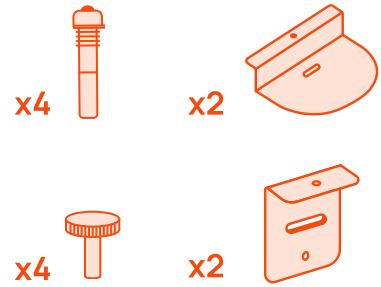

# b

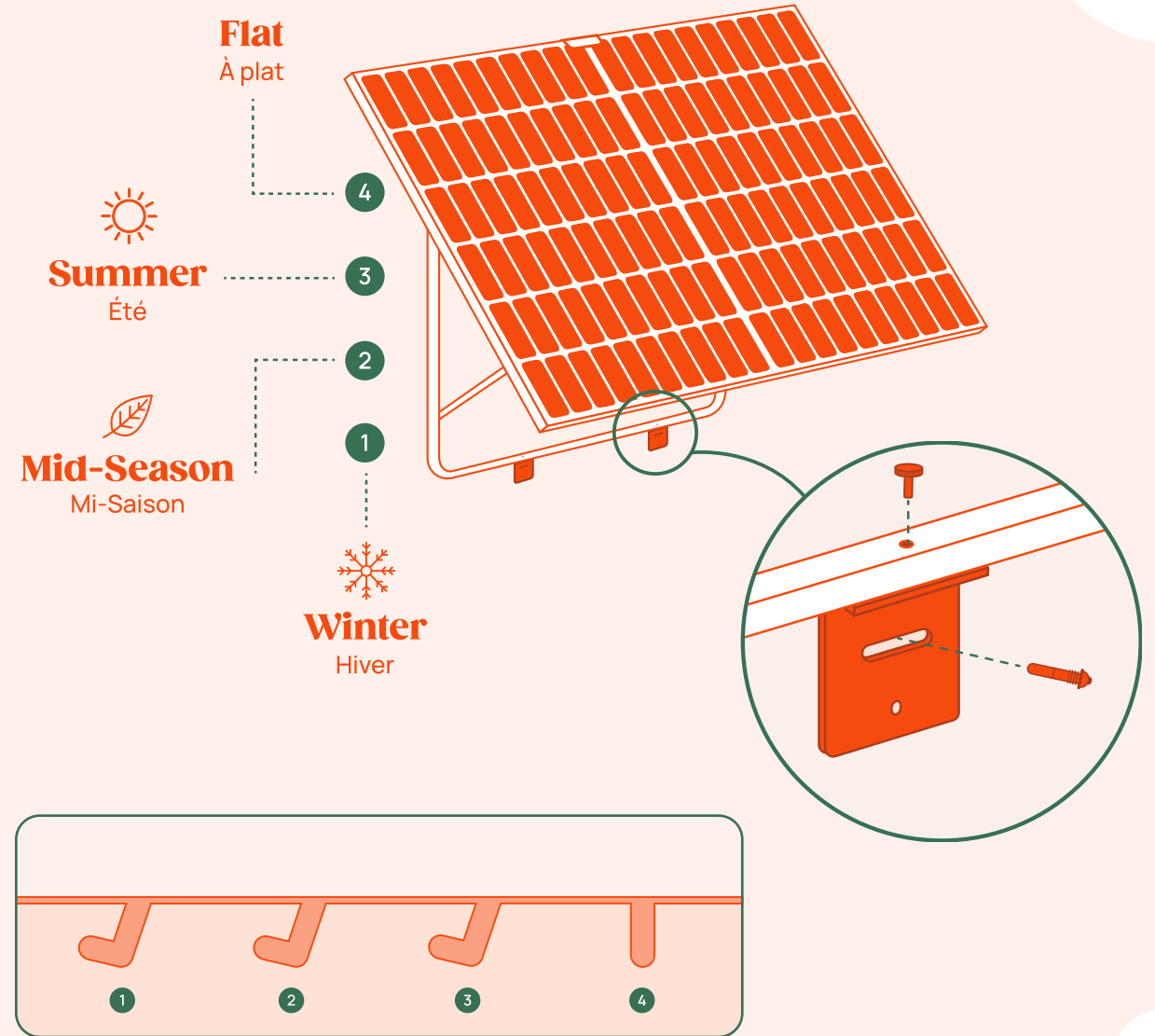



b

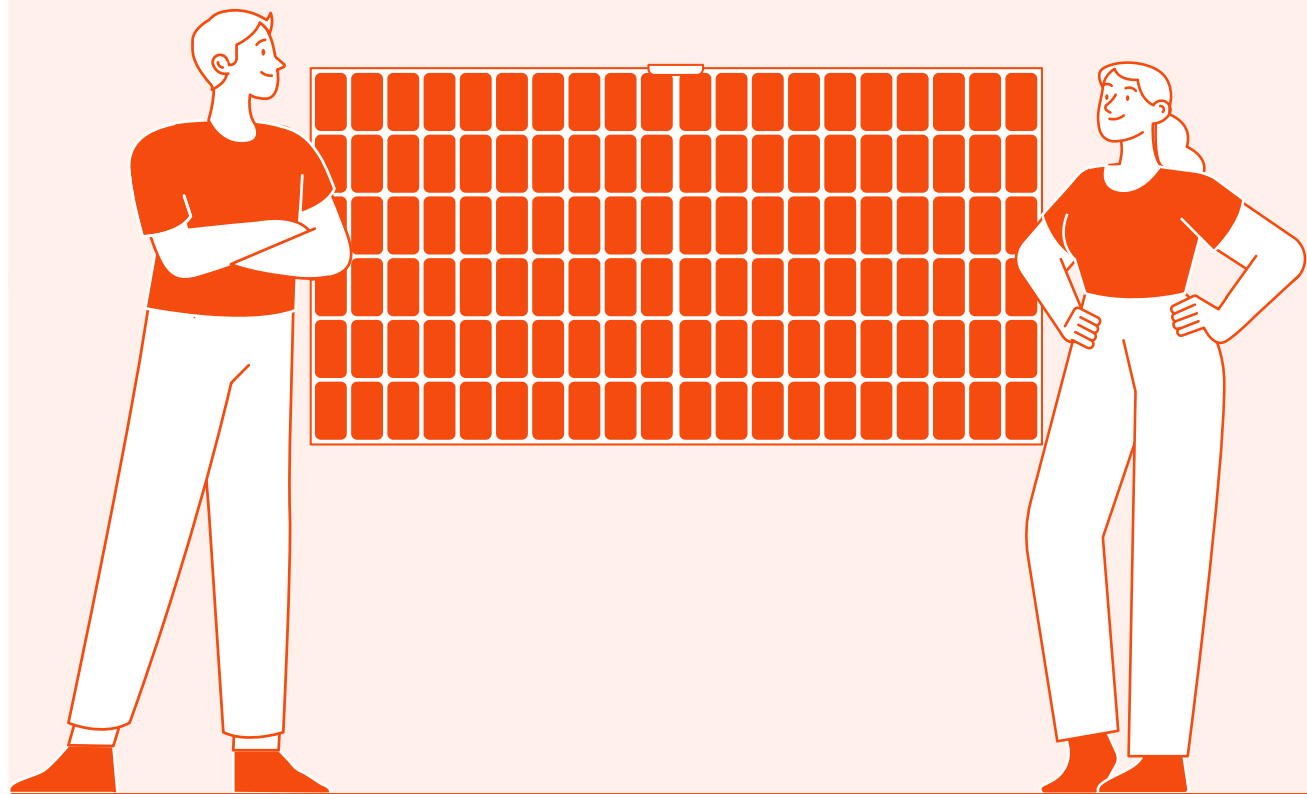

→ Page 30

c

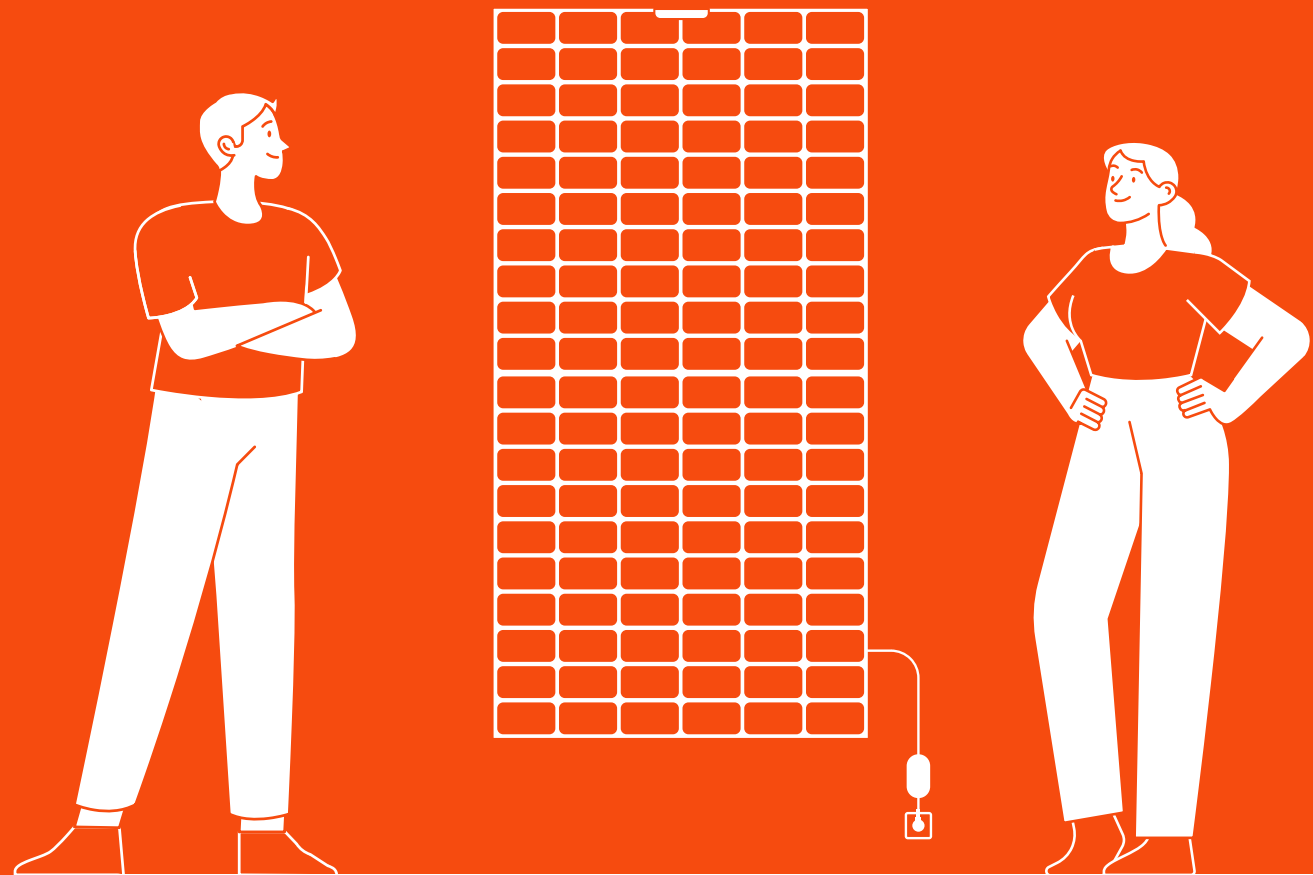

Start →

C

✘

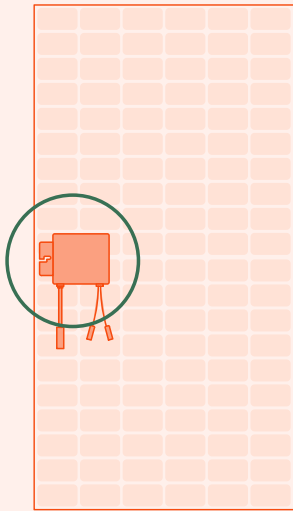

✔

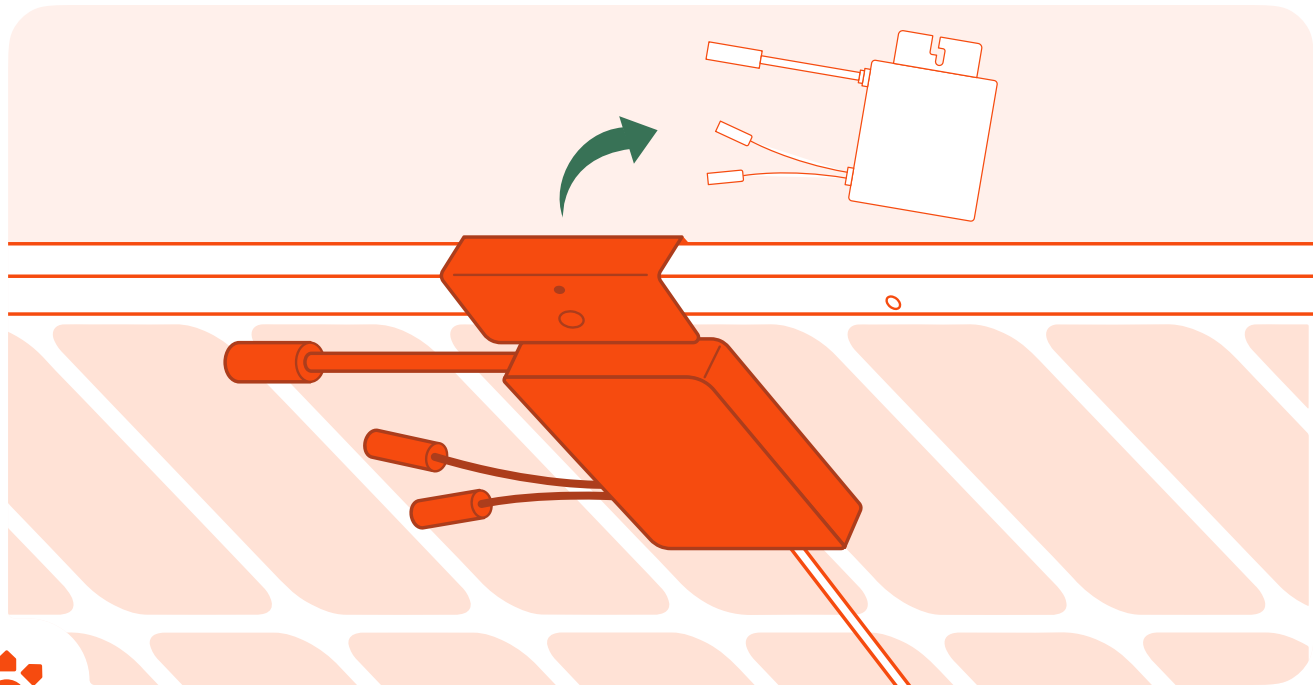
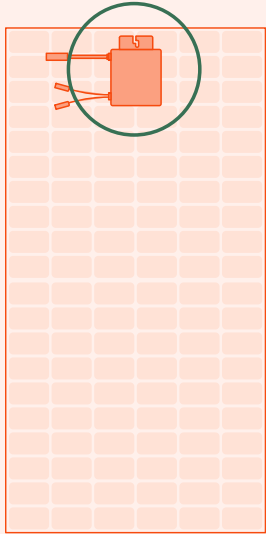

C

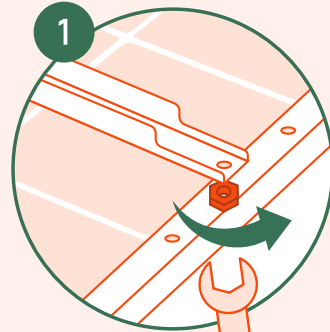

10 mm

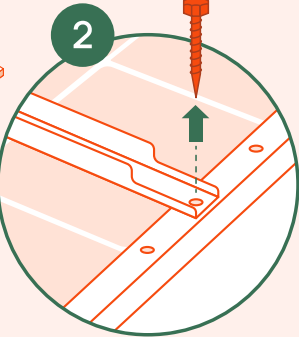
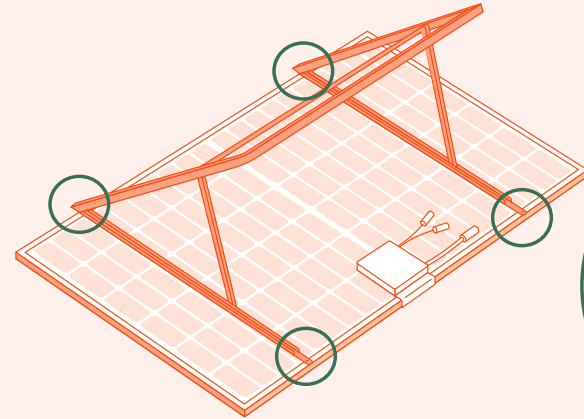

2

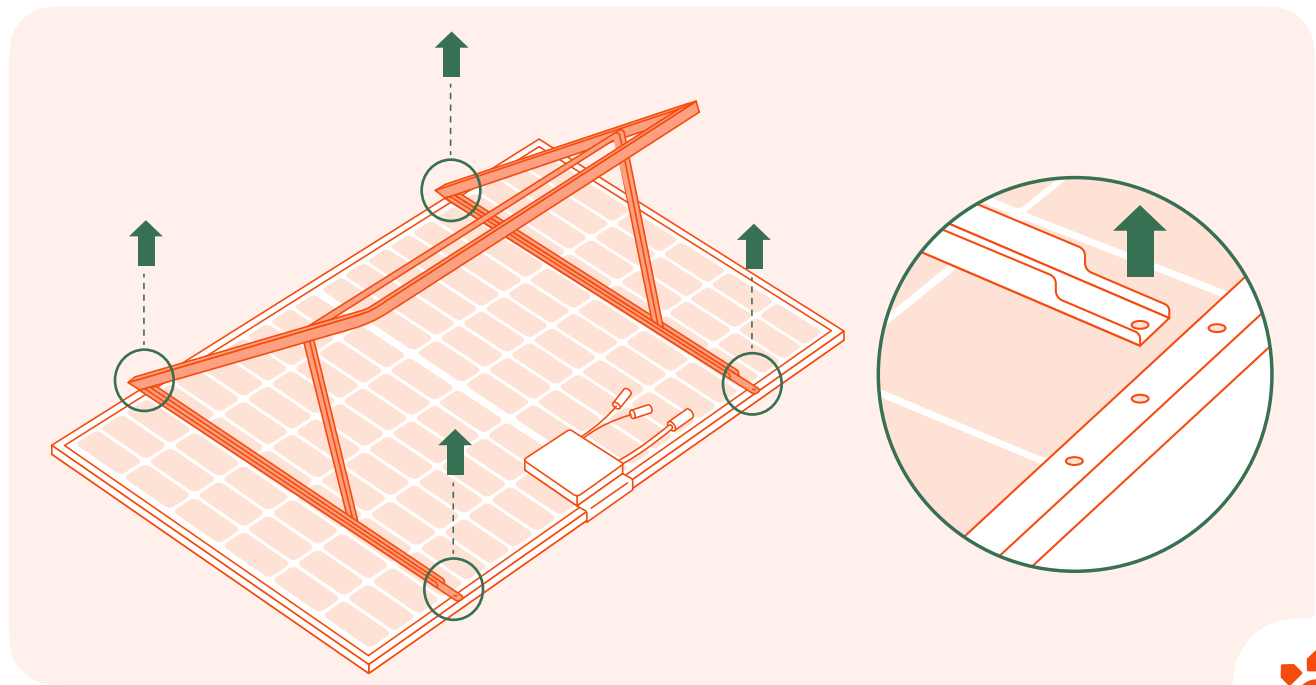

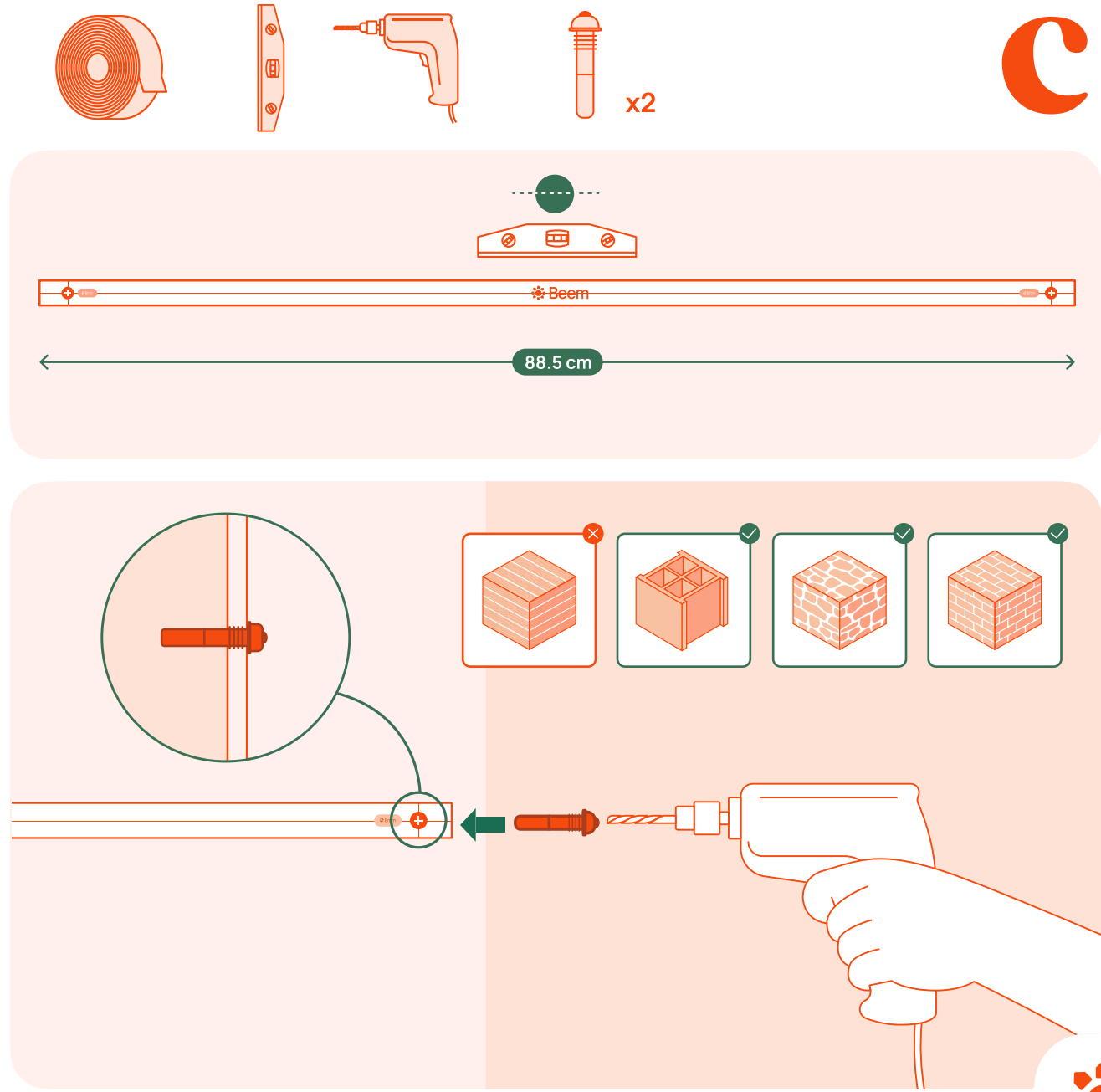
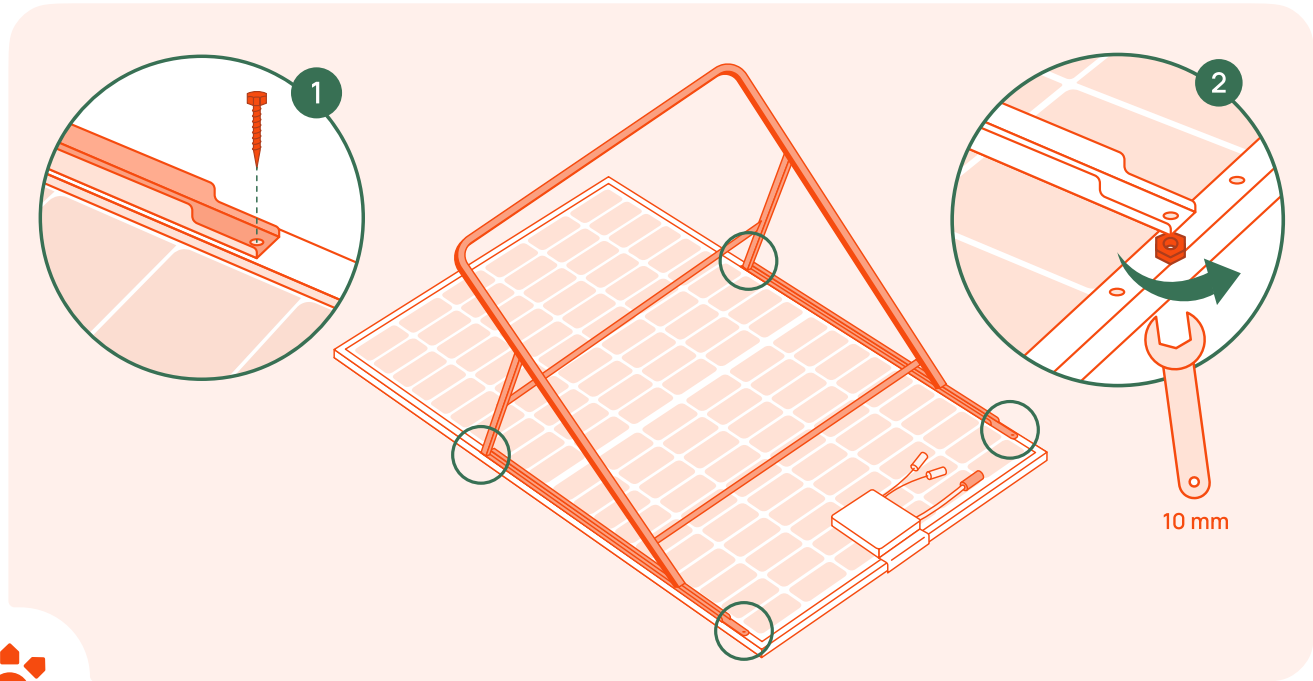
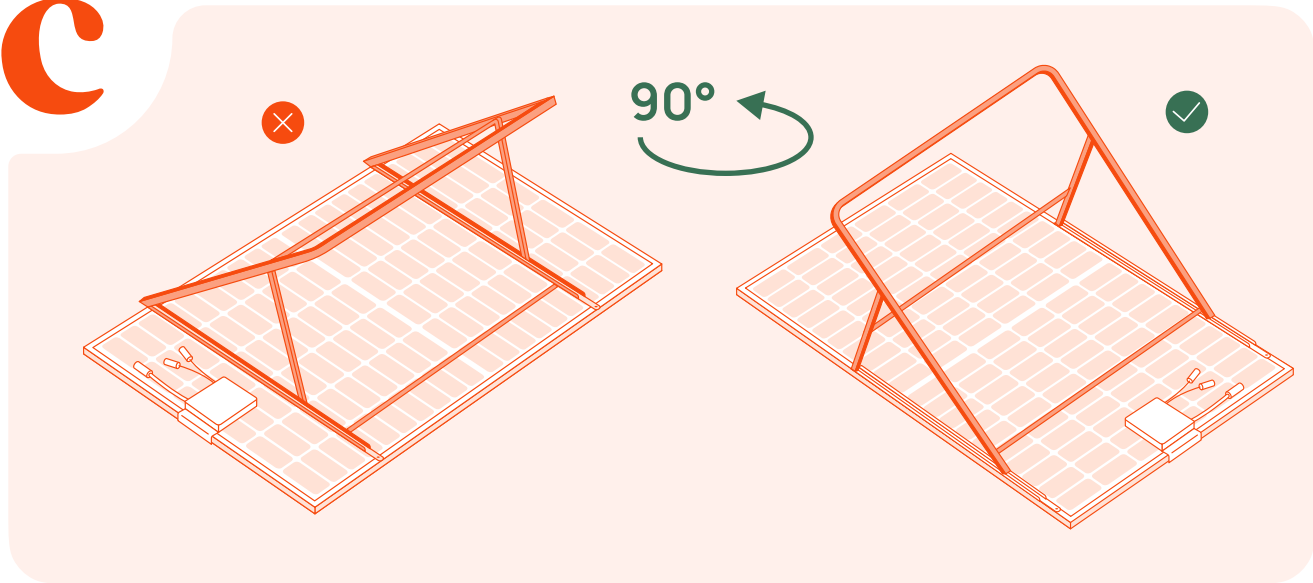

C

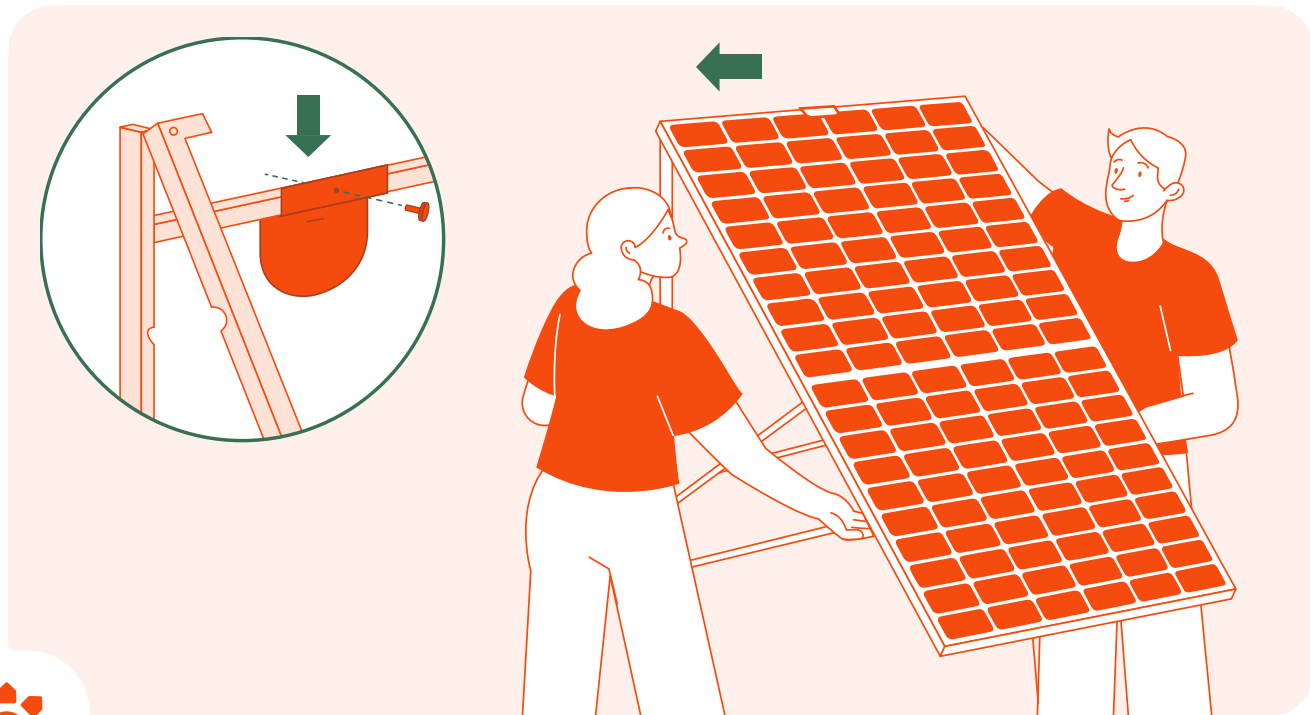
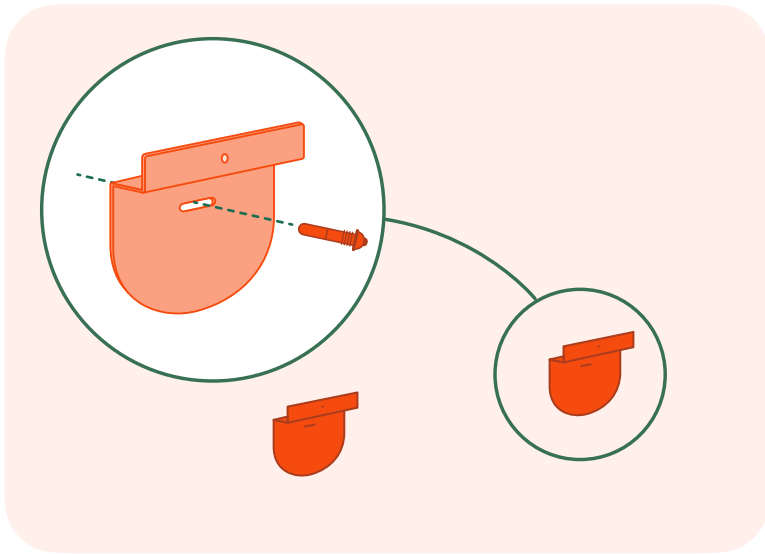
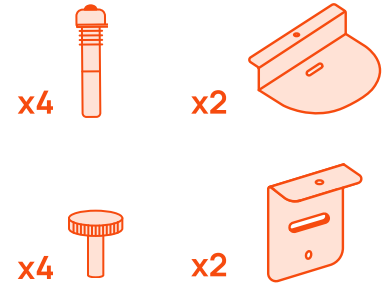

C

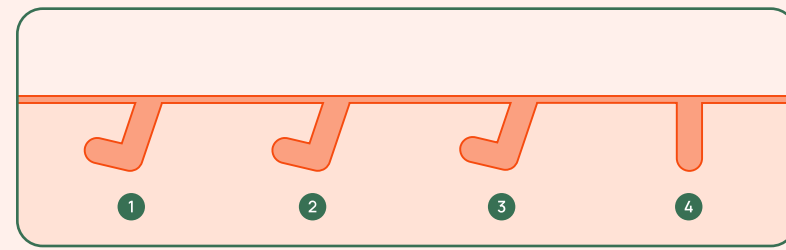
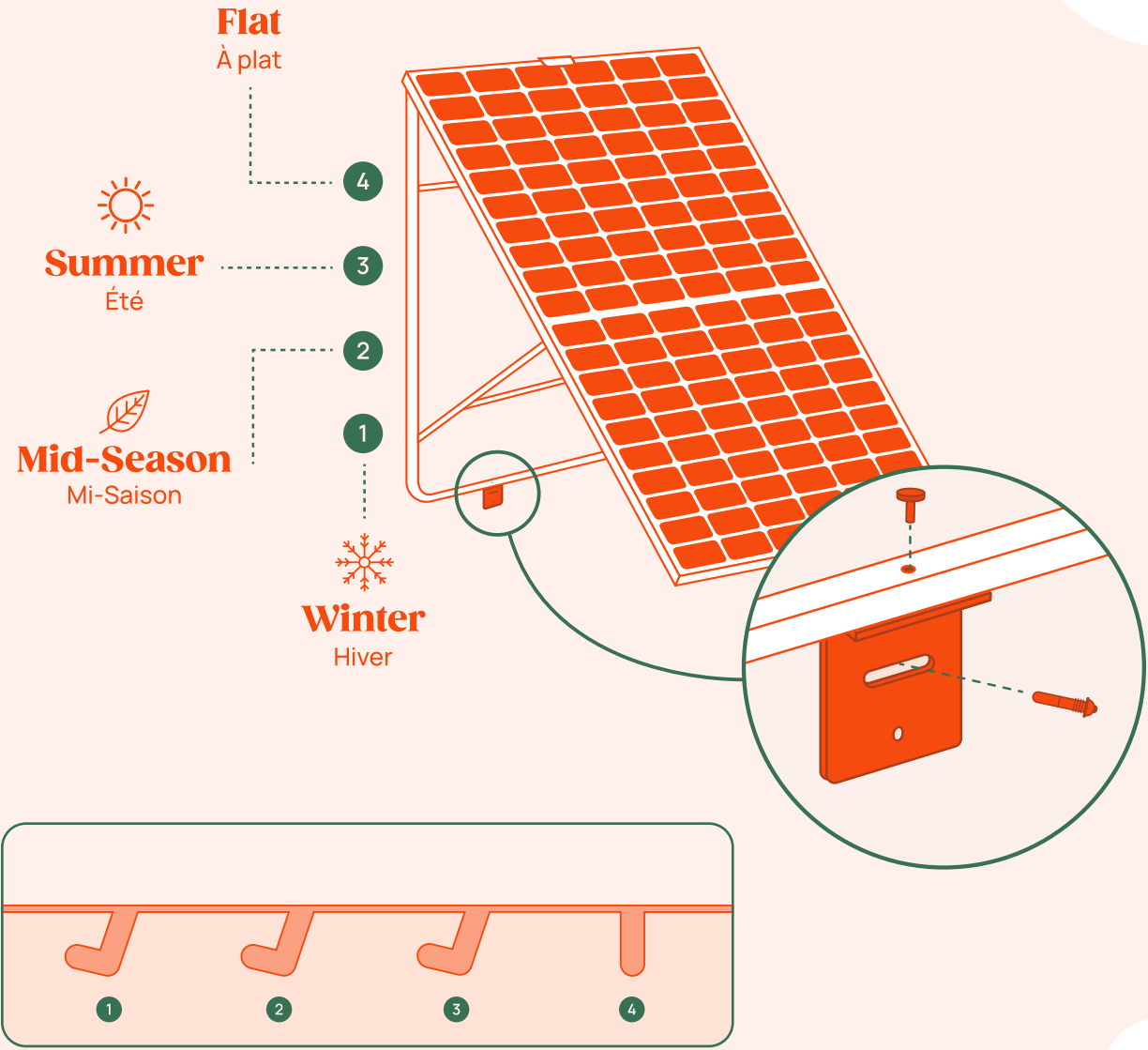

c

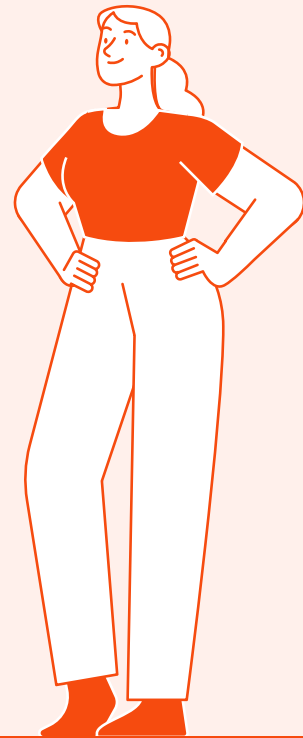
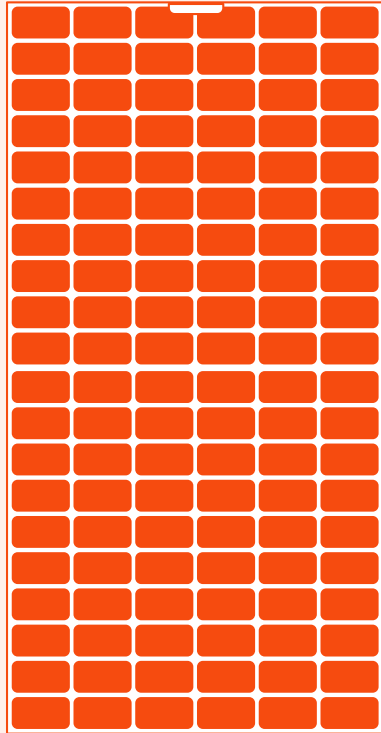
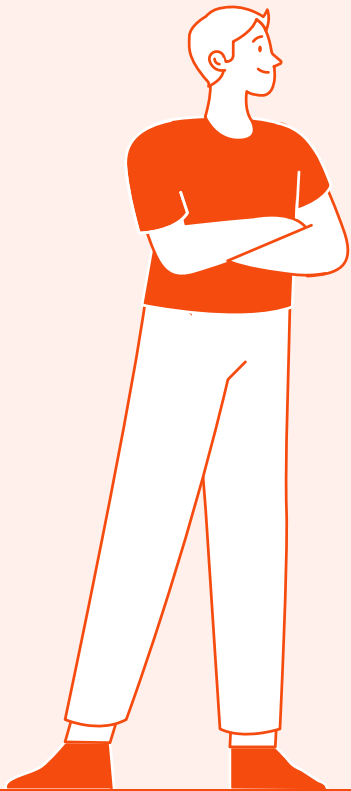

→ Page 30



d

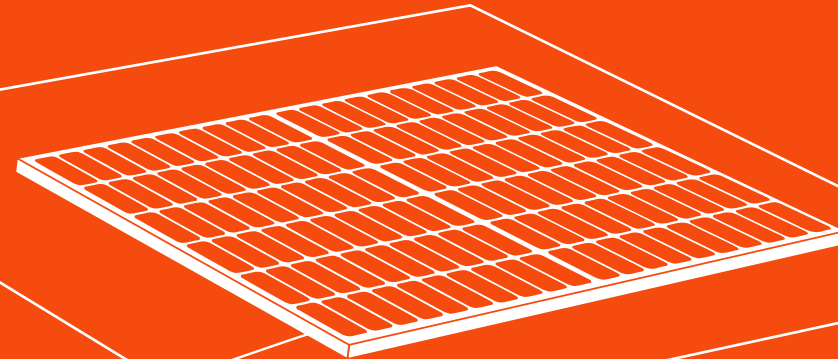

Start →

d

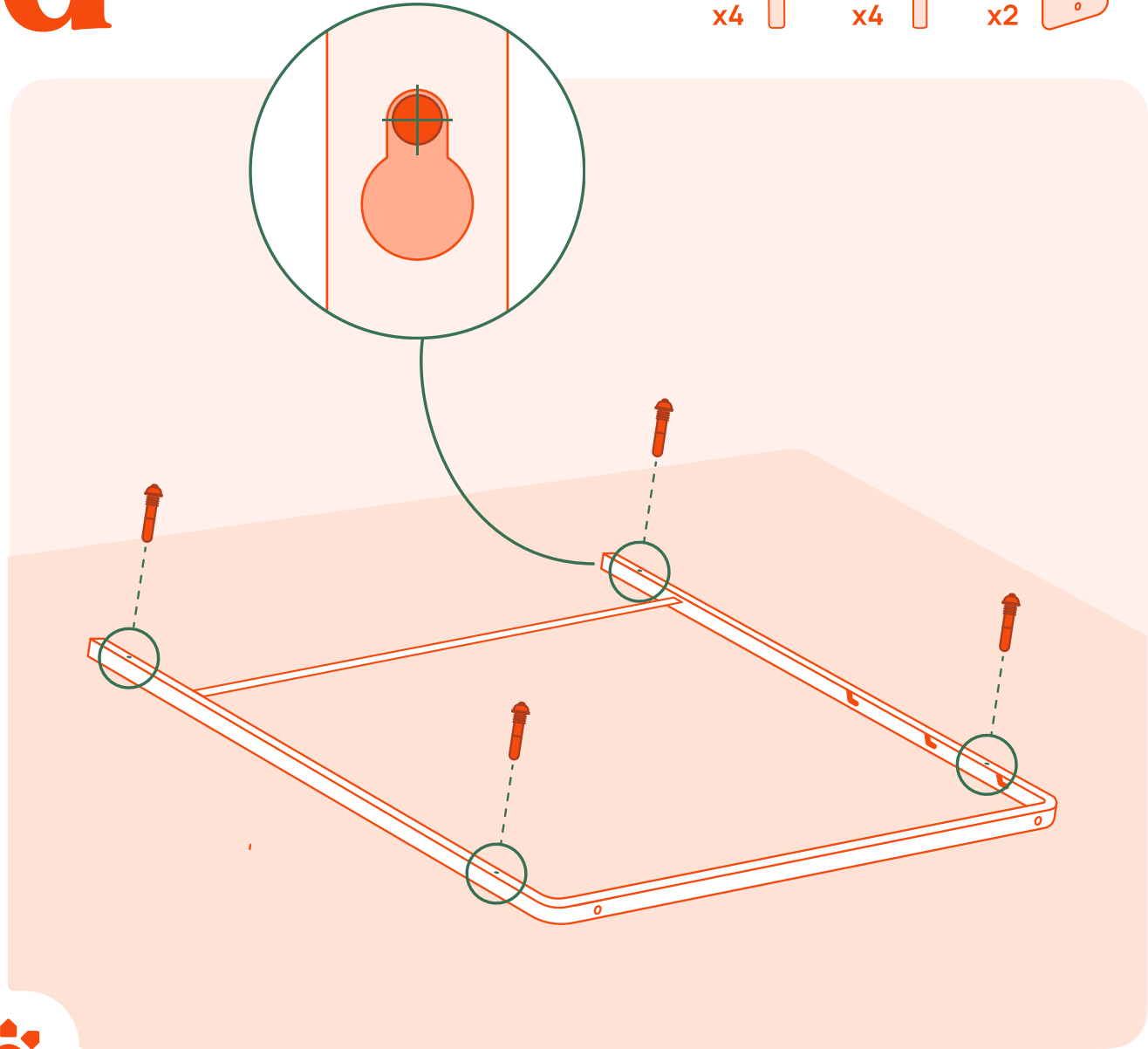

d

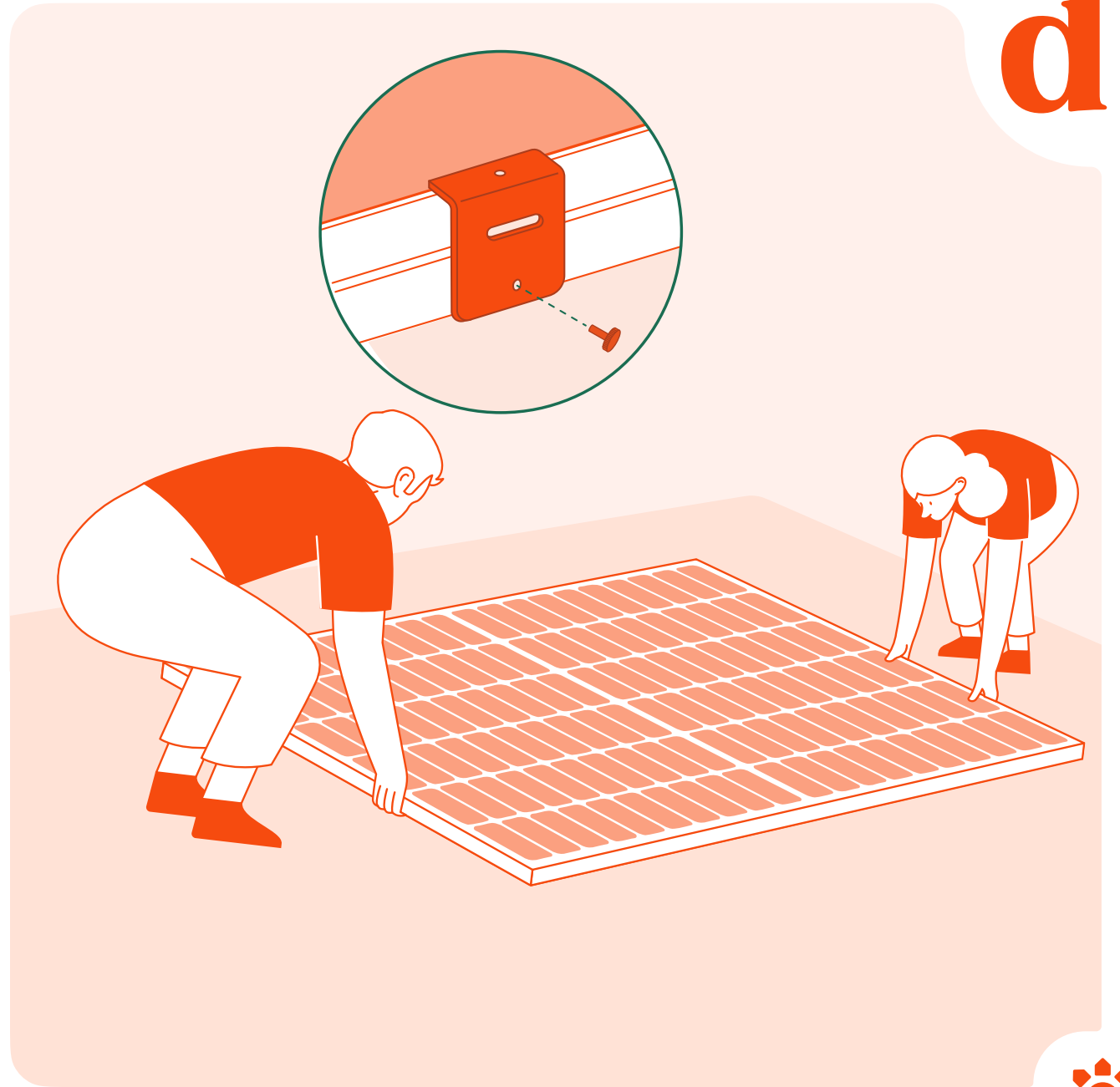

d

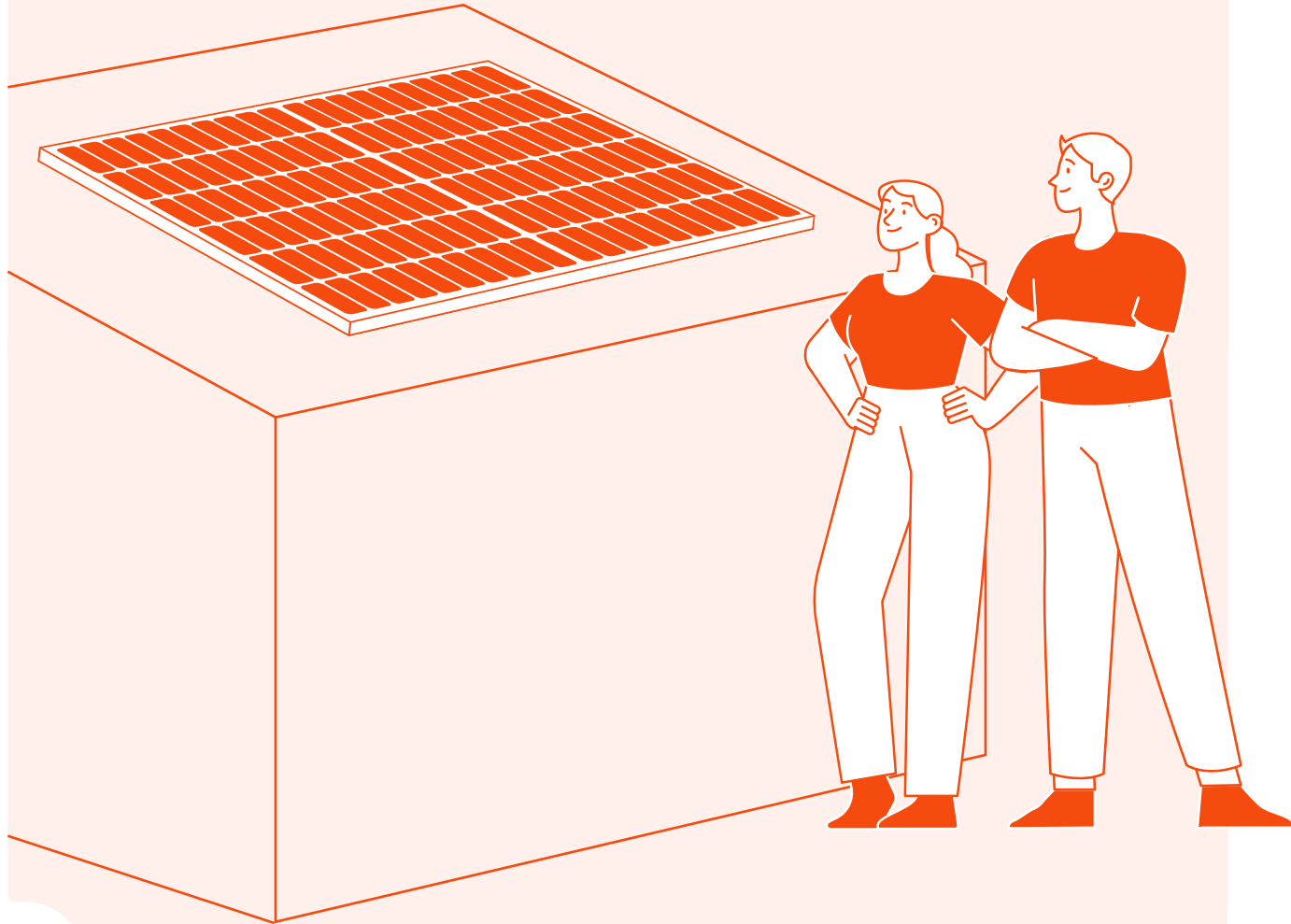

**Now let's  
Plug!**



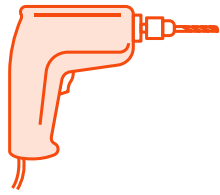

x1



x1

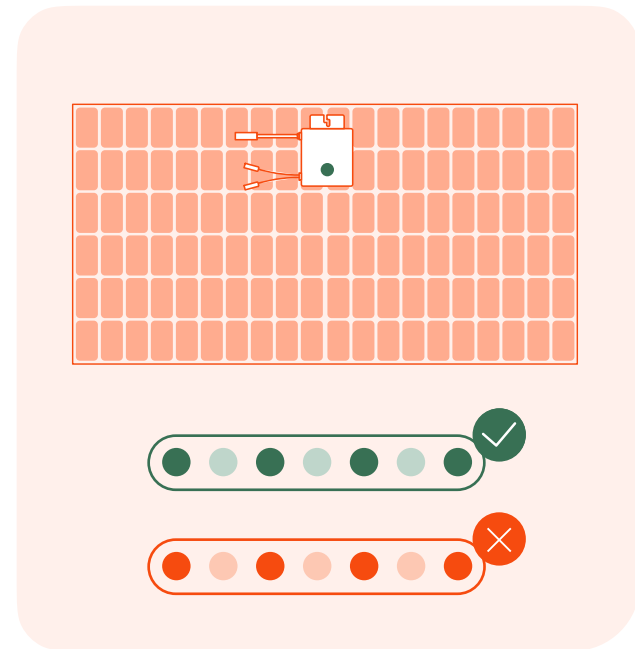
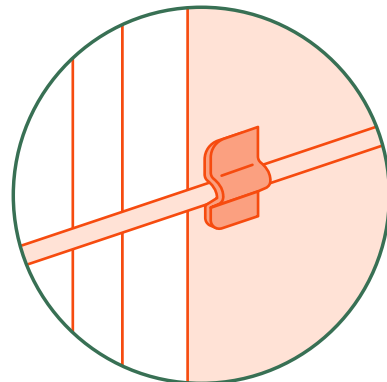
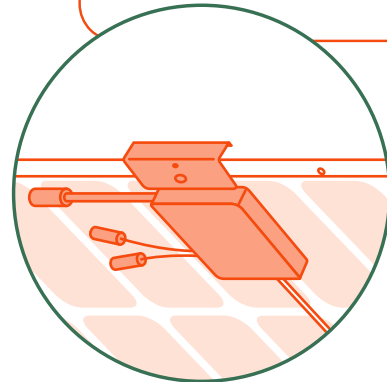
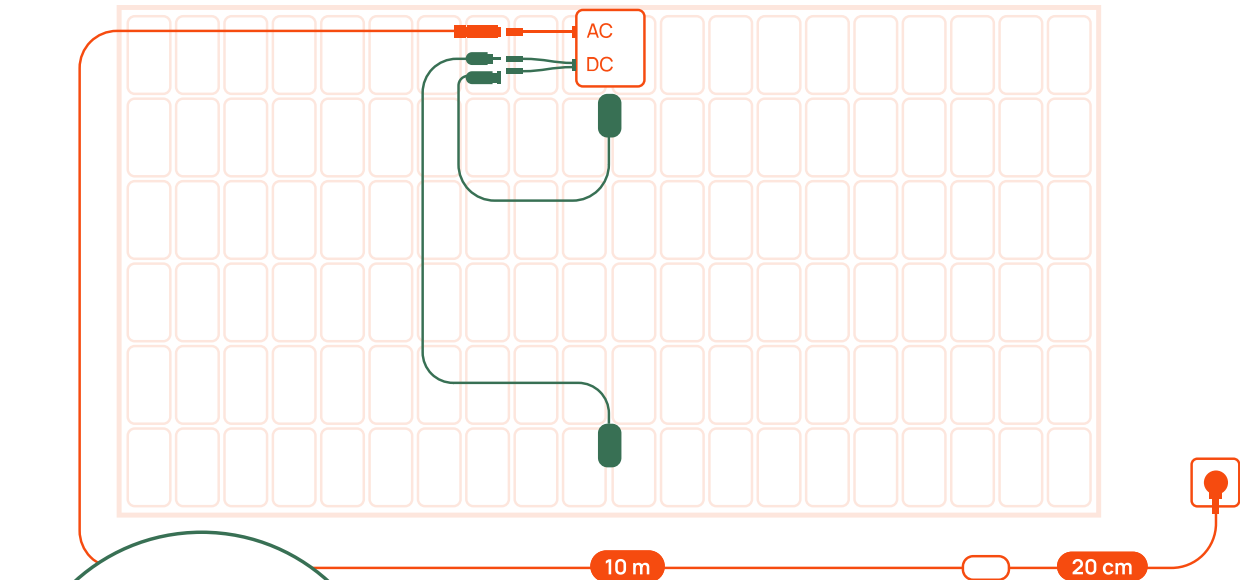
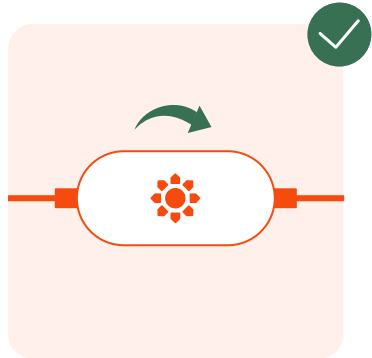
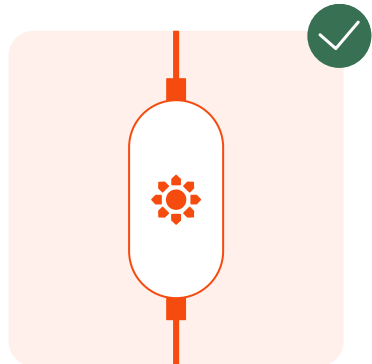
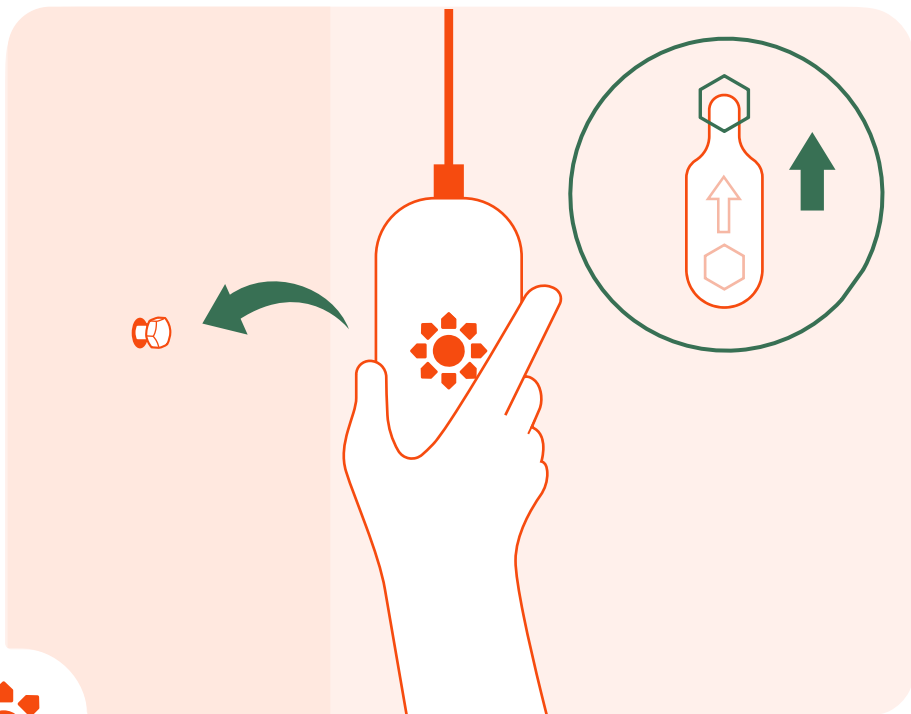
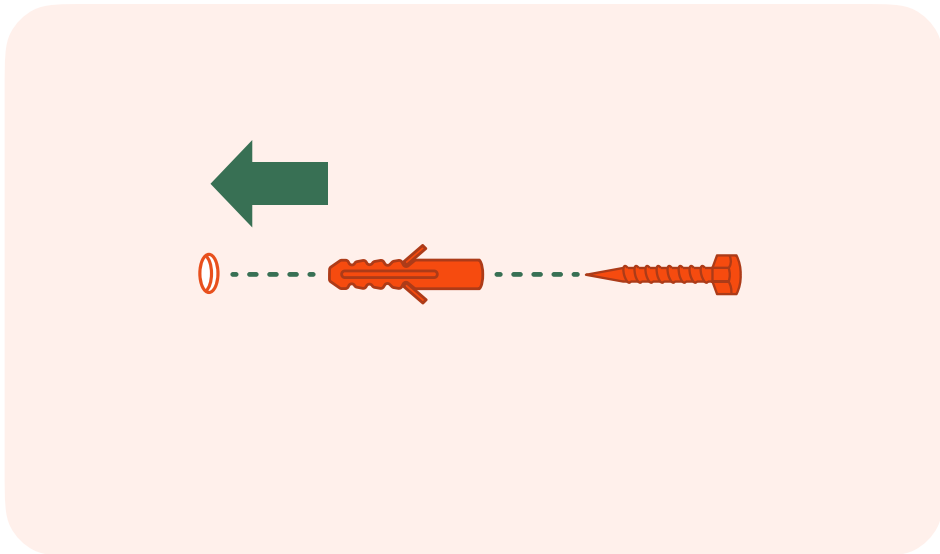



# Beembox

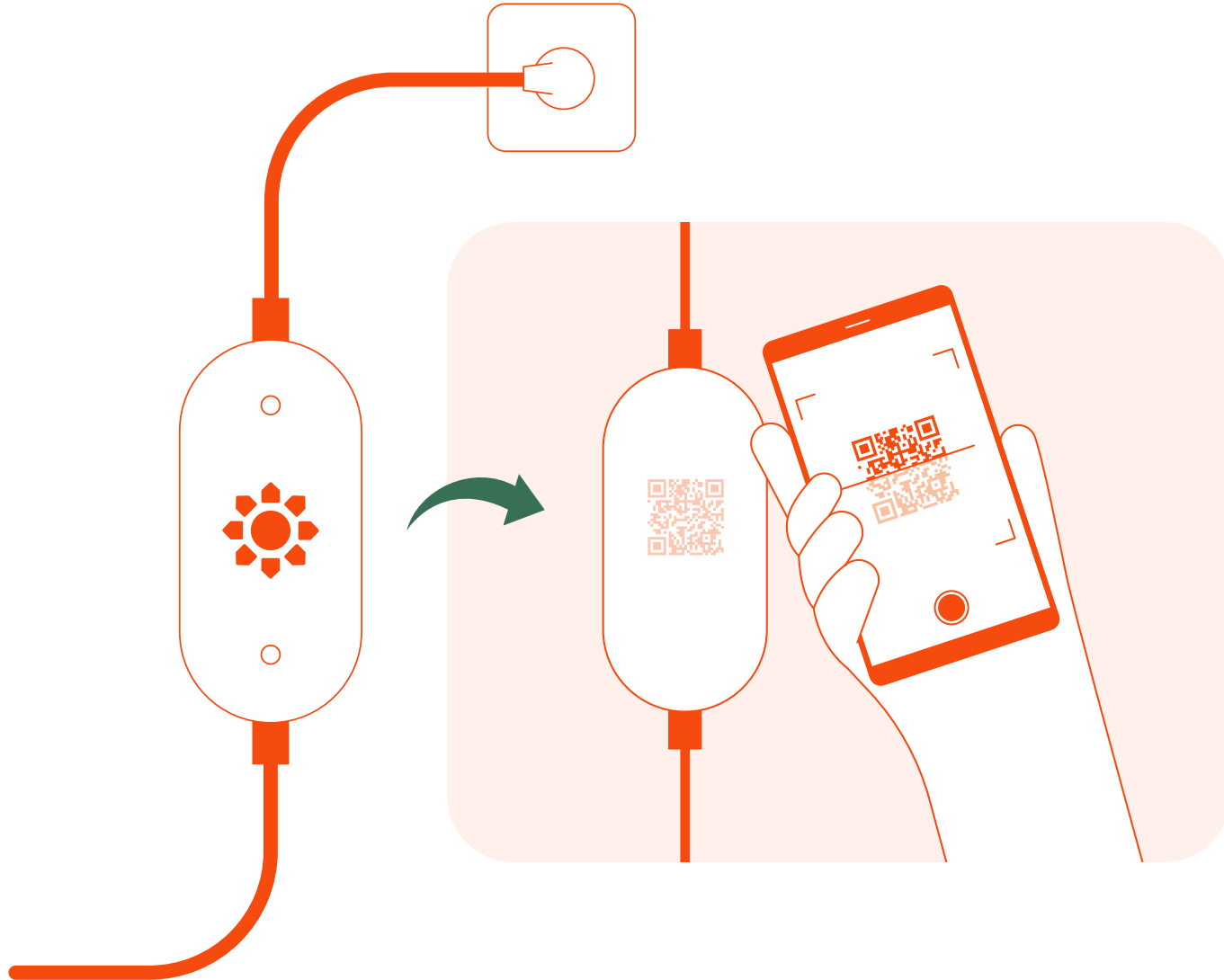

# App

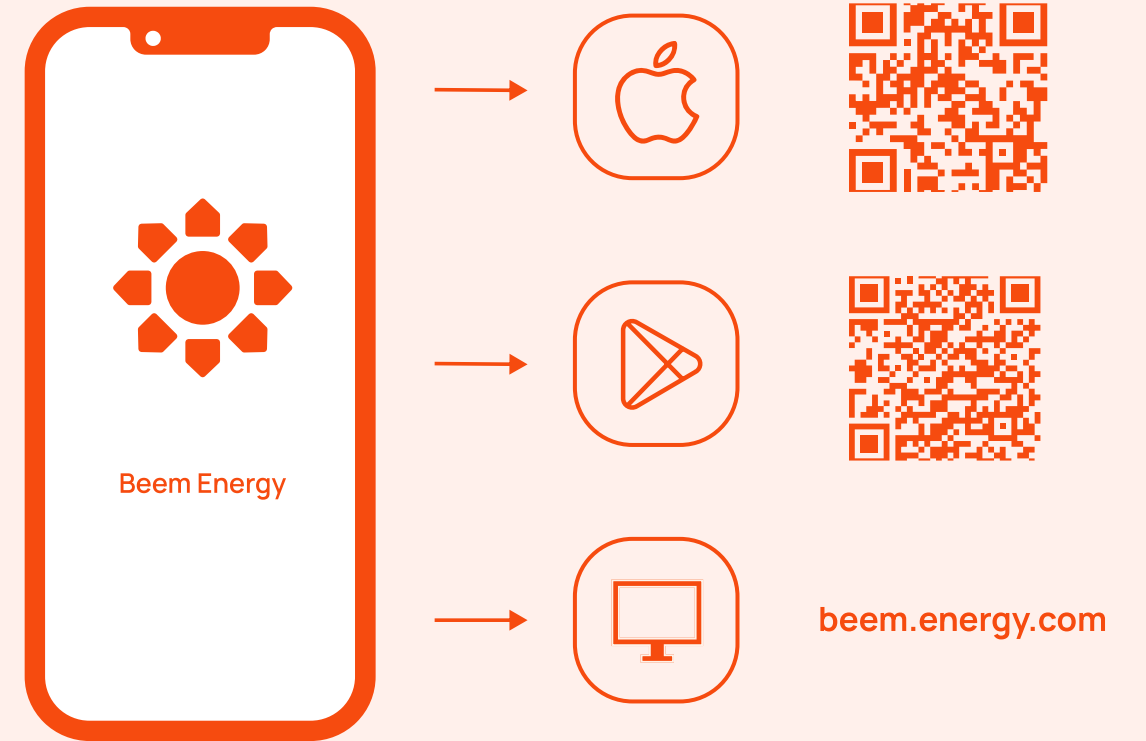

# Extension

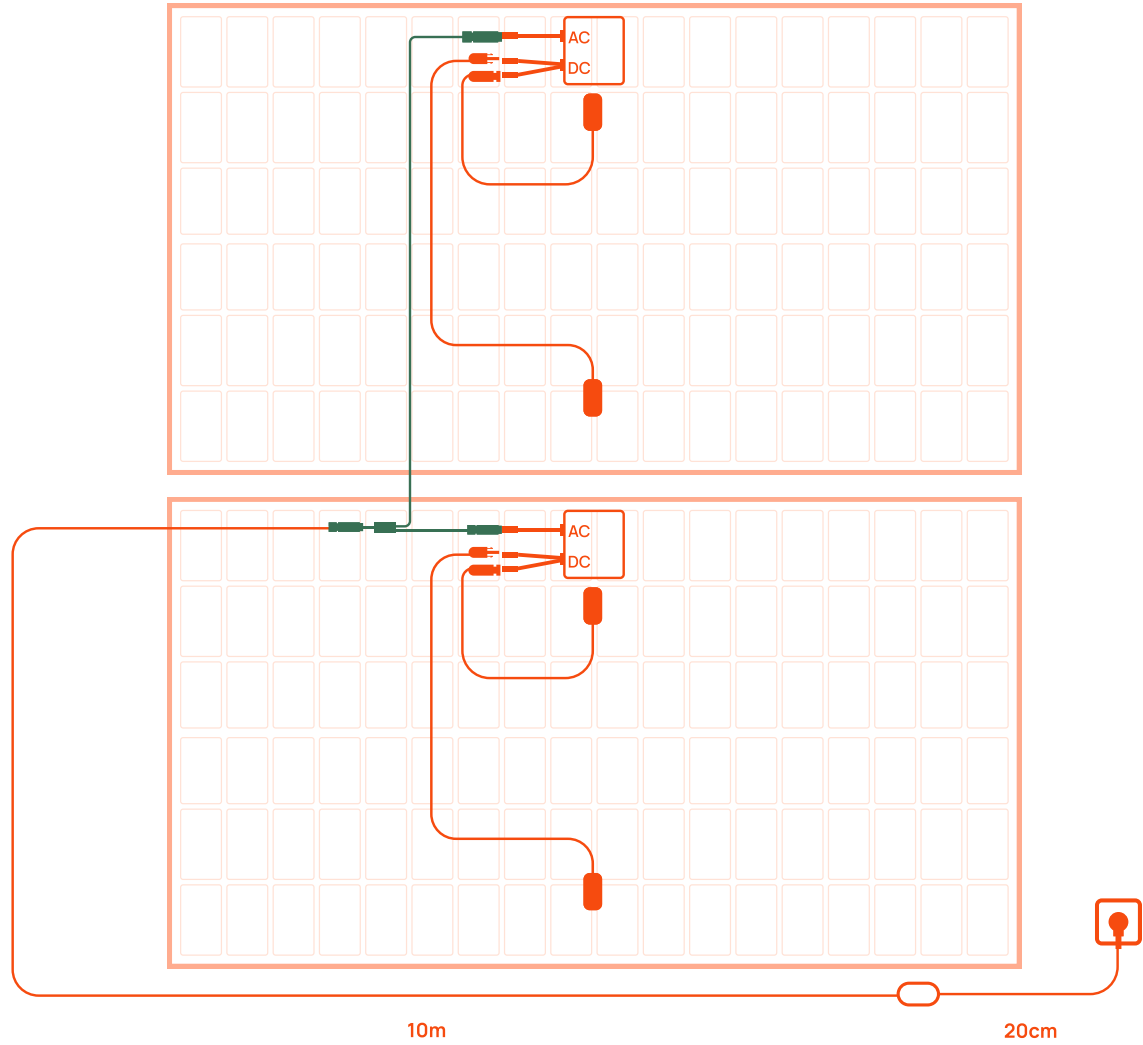

# Extension

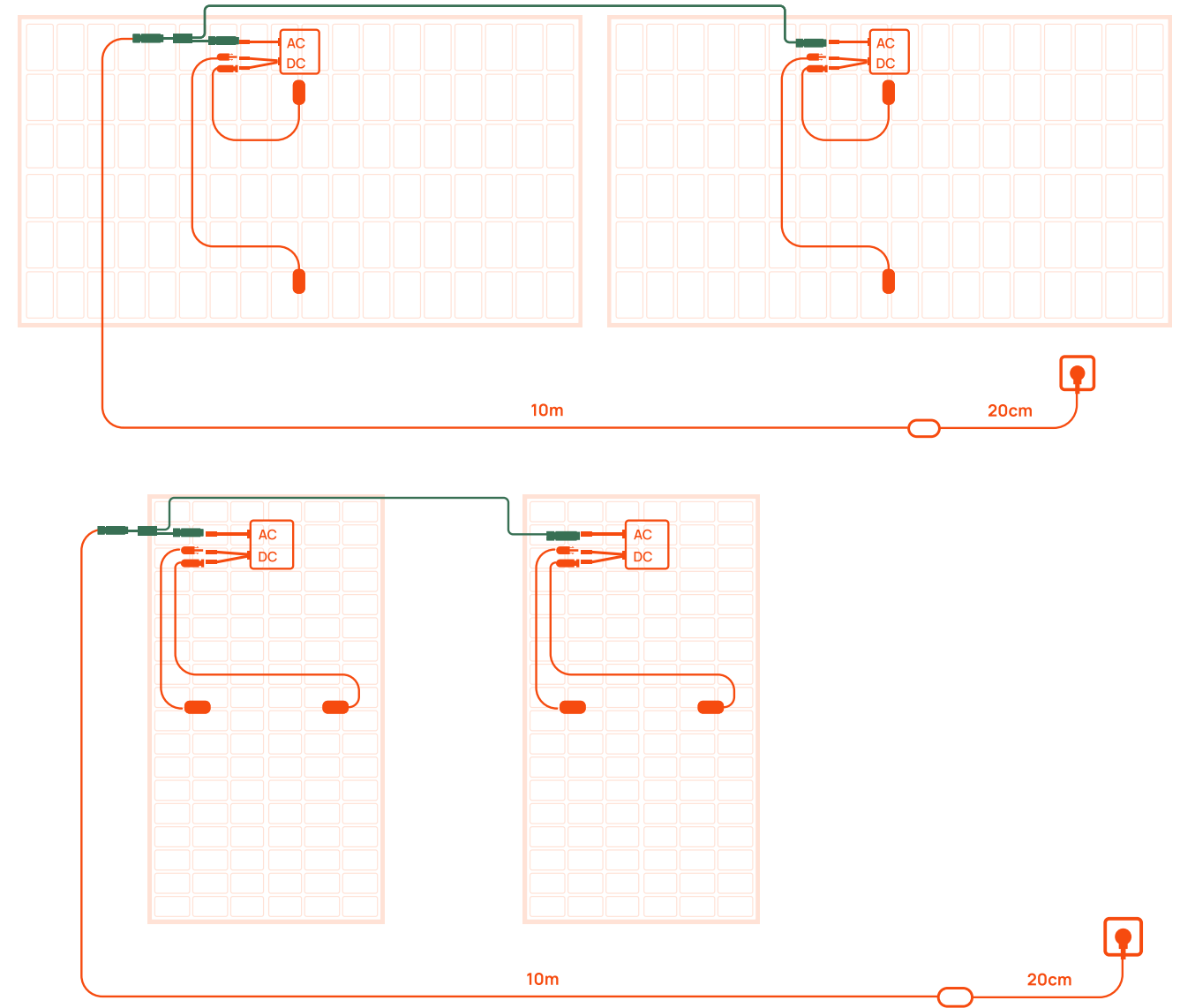



***You've got the  
power!***

[beemenergy.com](http://beemenergy.com)